



Bid description: Collection and transportation of (G) Waste in Nkowankowa and Bulk Waste Removal in Region South for 3 years

Bid No: SCMU 09/2021

Name of the bidder/s:

Bid Amount (VAT Inc.): R.....

Amounts in words.....
.....
.....
.....**Rand**

This tender closes at 12h00 on Monday, 19 July 2021 at the Council Chambers, in offices of the Greater Tzaneen Local Municipality located at 38 Agatha Street, Civic Centre Building, Tzaneen, 0850

NO LATE SUBMISSIONS WILL BE CONSIDERED



**MBD1
GREATER TZANEEN MUNICIPALITY
GROTER TZANEEN MUNISIPALITEIT
MASIPALA WA TZANEEN
MASEPALA WA TZANEEN**



**SUPPLY CHAIN MANAGEMENT UNIT
DEPARTMENT: COMMUNITY SERVICES-SOLID WASTE**

BID DESCRIPTION: Collection and transportation of (G) Waste in Nkowankowa and Bulk Waste Removal in Region South for 3 years

BID NO: SCMU 09/2021

Interested bidders must attach proof of the following documents to avoid disqualification:

CSD report (not older than 3 months), certified copies of ID's for all directors of the company, statement of municipal rates and taxes for both company and directors appearing in the CK (not older than 3 months)/ letter from traditional authority not older than 3 months for the company and the directors/ lease agreement (attach 3 months proof of payment for lease [not older than 3 months]), valid tax pin or tax clearance, certified or original B-BBEE certificate (combined BBBEE certificate if Joint Venture), signed joint venture agreements in case of a joint venture companies, Reviewed Annual Financial Statement (AFS), a letter of good standing from Department of Labour, initial every page of the bid document.

Bidders must sanitise/ wear gloves when preparing their bid document. Completed bid documents with attachments (supporting documents) must be wrapped in a sealed envelope and be deposited into Greater Tzaneen Municipality bid box, Civic Centre, Agatha Street, marked as Bid No: SCMU 09/2021, postal address and contact details of the bidder.

Bid document will be available only at www.greatertzaneen.gov.za on the date of advert.

Closing date: 19 July 2021 @ 12:00. Bidders must note that briefing session will take place on the 29 June 2021. Public bid opening will be held on the closing date at 12h00, Council Chambers.

EVALUATION OF BIDS

N.B: The evaluation of the bid will be conducted in two stages, first stage will be the assessment on functionality as follows: Relevant company experience - 30 points; key personnel experience – 20 points; Plant and Equipments-50 points. Attach e-Natis as proof of ownership of plant; Attach a roadworthy certificate, not older than 6 months, as proof that the plant is in good working order. Only bidders that obtain 70 points will be subjected to 80/20 Preference point scoring system, where 80 points will be allocated for price only and 20 points will be allocated based on the Broad Based Black Economic Empowerment (B-BBEE) status level of contributors.

Bidders shall take note of the following bid conditions:

- a. Greater Tzaneen Municipality Supply Chain Management Policy will apply on this bid;
- b. Broad Based Black Economic Empowerment (B-BBEE) Act will apply on this bid;

- c. Greater Tzaneen Municipality does not bind itself to accept the lowest or any bid and reserves the right to accept the whole or part of the bid;
- d. Contract period: **36 months**
- e. Council reserves the right to negotiate further conditions with the successful bidder;
- f. Council reserves the right not to appoint;
- g. No bidder will be appointed if not registered on Central Supplier Database;
- h. Council have the right to appoint more than one bidder;
- i. Late, incomplete, unsigned, faxed or emailed bids will not be accepted.

Technical enquiries should be directed to Ms M. Machumele @ 015 307 8296

Administrative enquiries relating to the tender be directed to Ms. M. Mpyana @ 015 307 8091

Mr. B.S. Matlala
Municipal Manager
Greater Tzaneen Municipality

PART B.1 Form of bid

Bid for contract number: SCMU 09/2021

I/We, the undersigned:

Bid for an amount % (vat inclusive) and;

- a) Bid to supply and deliver to the Greater Tzaneen Municipality all or any of the supplies of goods described in both Specification and Scheduled of this Contract;
- b) Agree that we will be bound by the specifications, prices, terms and conditions stipulated in those Schedules attached to this bid document, regarding delivery and execution;
- c) Further agree to be bound by those conditions, set out should this bid be accepted in whole or in part.
- d) Confirm that this bid may only be accepted by the Greater Tzaneen Municipality by way of a duly authorized Letter of Acceptance; and,
- e) Declare that we are fully acquainted with the Preferential Procurement Forms and Schedules, and the contents thereof and that we have signed the Schedule of Prices – PART “F” and completed the Preference Points claim Forms attached in Part I, J, K, L and M; N; O”
- f) Declare that, the relevant authorised person thereto will initial each page of the bid document and amendment.
- g) Declare that all information provided in respect of the bidder as well as the bid documents submitted are true and correct.
- h) Declare that documentary proof regarding aspects of the bid process or accidental thereto will, when required, be submitted to the satisfaction of the Municipality.

Signed atthis Day of20..... Signature

Name of Firm: _____ Address: _____

As Witness:

- 1. Name _____ Date ___/___/_____ Signature: _____
- 2. Name _____ Date ___/___/_____ Signature: _____

State in cases where the bidder is a Company, Corporation of Firm by what authority the person signing does so, whether by Articles of Association, Resolution, Power of Attorney or otherwise. I/We the undersigned am/are authorized to enter into this contract on behalf of:

By virtue of _____

Dated _____ a certified copy of which is attached to this bid. Signature of authorized person: _____

Name of Firm: _____

Postal Address: _____

As witness:

1. Name: _____ Date ___/___/___ Signature: _____

2. Name: _____ Date ___/___/___ Signature: _____

Please Note: The prices at which bids are prepared to supply the goods and materials or perform the services must be placed in the column on the form provided for that purpose. Failure to sign the form of bid and initialling each page of the bid document will result in disqualification of the bidder. Bidders must sign this Form of Bid as well as PART "F," attached to this bid document and on acceptance of a bid by the Greater Tzaneen Municipality the Conditions of Contracts, Special Conditions, Specifications and Scheduled of prices, attached hereto shall be deemed to be the conditions of Contract between the parties.

Failure to complete all blank spaces in the forms and to attend to the other details mentioned herein will render the bid liable to rejection.

Bank account details of Bidder:

Bank: _____

Branch: _____

Branch Code: _____

Account Number: _____

Type of Account: _____

Proof that municipal account is paid in full to be attached (arrangements made with council will be taken into consideration).

Part B. 2 Bidding Information

Details of person responsible for bidding process Name:

Contact number: _____

Address of office submitting bid: _____

Telephone: _____

Fax no: _____

E-mail address: _____

Authority for signatory Signatories for close corporation and companies shall confirm their authority by attaching to this form a duly signed and dated copy of the relevant resolution of their members or their board of directors, as the case may be. An example for a company is shown below:

“By resolution of the board of director(s) passed on ____/____/20____

Mr/ Mrs. _____

Has been duly authorized to sign all documents in connection with the bid for

Contract _____

No _____

And any contract, which may arise there from on behalf of Signed on behalf of the company:

In his capacity as: _____ Date: ____/____/____

Signature of signatory as witness:

1. Name _____ Date ____/____/____ Signature: _____

2. Name _____ Date ____/____/____ Signature: _____

Part C General undertakings by the bidder

1.1 Definitions

1.1.1 “Acceptable bid” means any bid, which in all respects, complies with conditions of bid and specifications as set out in the bid document, including conditions as specified in the Preferential Procurement Policy Framework Act (Act 5 of 2000) and related regulations.

1.1.2 “Chairperson” means the chairperson of the Greater Tzaneen Municipality Bid Adjudication Committee.

1.1.3 “Municipal Manager” means the Accounting Officer or Municipal Manager of the Municipality.

1.1.4 “Committee” refers to the Bid Adjudication Committee.

1.1.5 “Council” refers to Greater Tzaneen Municipality.

1.1.6 “Equity Ownership” refers to the percentage ownership and control, exercised by individuals within an enterprise.

1.1.7 “HDI equity ownership” refers to the percentage of an enterprise, which is owned by individuals, or in the case of a company, the percentage shares that are owned by individuals meeting the requirements of the definition of a HDI.

1.1.8 “Member” means a member of the Bid Adjudication Committee.

1.1.9 “Historically Disadvantaged Individual (HDI)” means a South African citizen- (i) Who, due to the apartheid policy that had been in place, had no franchise in national elections prior to the introduction of the 1983 and 1993 Constitutions; and/or (ii) Who is a female; and/ or (iii) Who has a disability?

1.1.10 “Service providers” refers to the bidders who have been successful in being awarded Council contracts.

1.1.11 “SMMs” (Small, medium and Micro Enterprises) refers to separate and distinct business entities, including co-operative enterprises and NGOs, managed by one owner or more, as defined in the National Small Business (Act 102 of 1996).

1.1.12 “Contract” refers to legally binding agreement between Greater Tzaneen Municipality and the service provider.

1.1.13 “Bid” means a written offer in a prescribed or stipulated form in response to an invitation by the Municipality for the provision of services or goods

1.1.14 “Contractor” means any natural or legal person whose bid has been accepted by the Council.

1.1.15 “Closing time” means the date and hour specified in the bid documents for the receipt of bids.

1.1.16 “Order” means an official written order issued for the supply of goods or the rendering of a service in accordance with the accepted bid or price quotation.

1.1.17 “Written” or “in writing,” means hand written in ink or any form of mechanical writing in printed form.

1.1.18 Functionality” means technical capability, financial and other resource availability that the service provider needs, to successfully and efficiently render the service and/or deliver in accordance with the specifications.

1.2 INTERPRETATION:

1.2.1 In this agreement clause headings are for convenience and shall not be used in its interpretation and, unless the context clearly indicates a contrary intention: -

1.2.2 An expression which denotes: -

1.2.3 Any reference to any statute, regulation or other legislation or official policy shall be a reference to that statute, regulation or other legislation or national policy as at the signature date, and as amended or re-enacted from time to time.;

1.2.4 When any number of day is prescribed, such shall be reckoned exclusively of the first and inclusively of the last day, unless the last day falls on a day which is not a business day, in which case the last day shall be the next succeeding day which is a business day;

1.2.5 Where any term is defined within a particular clause, other than the interpretation clause, that term shall bear the meaning ascribed to it in that clause wherever it is used in this agreement.

1.3 I/we hereby Bid:

1.3.1 To supply all or any of the supplies and/or to render all or any of the services described in the attached documents {Forms, Schedule(s) and/or Annexure(s) to the Greater Tzaneen Municipality.

1.3.2 On the terms and conditions and accordance with the specifications stipulated in the bid documents (and which shall be taken as part of and incorporated into, this bid);

1.3.3 At the prices and on the terms regarding time for delivery and/or execution inserted therein.

2.1 I/we agree further that: The offer herein shall remain binding upon me/us and open for acceptance by the Greater Tzaneen Municipality during the validity period indicated and calculated from the closing time of the bid. This bid and its acceptance shall be subject to the terms and conditions contained in the Forms, Scheduled(s)

and/or Annexure(s) attached hereto with which I am /we are fully acquitted. notwithstanding anything to the contrary in the Form(s), Schedule(s) and /or Annexure(s) attached hereto:

2.1.1 if I/we withdraw my/our bid within the period for which I/we have agreed that the bid shall remain open for acceptance, or fail to fulfil the contract when called upon to do so, the Greater Tzaneen Municipality may, without prejudice to its other rights, agree to the withdrawal of my/our bid or cancel the contract that may have been entered into between me/us and the Municipality;

2.1.2 In such event, I/we will then pay to the Municipality any additional expenses incurred by the Municipality for having either to accept any less favourable bid or, if new bids have to be invited, the additional expenditure incurred by the invitation of new bids and by the subsequent acceptance of any less favourable bid;

2.1.3 The Municipality shall also have the right in these circumstances, to recover such additional expenditure by set-off against monies which may be due or become due to me/us under this or any other bid or contract or against any guarantee or deposit that may have been furnished by me/us or on my/our behalf for the due fulfilment of this or any other bid or contract;

2.1.4 Pending the ascertainment of the amount of such additional expenditure the Municipality may retain such monies, guarantee or deposit as security for any loss the Municipality may sustain, as determined hereunder, by reason of my/our default.

2.1.5 Any legal proceedings arising from this bid may in all respects be launched or instituted against me/us and if/we hereby undertake to satisfy fully any sentence or judgment which may be obtained against me/us as a result of such legal proceedings and I/we undertake to pay the Greater Tzaneen Municipality legal costs on an attorney and own client;

2.1.6 if my/our bid is accepted that acceptance may be communicated to me/us by letter or facsimiles and that proof of delivery of such acceptance to SA Post Office Ltd or the production of a document confirming that a fax has been sent, shall be treated as delivery to me/us. The law of the Republic of South Africa shall govern the contract created by the acceptance to this bid.

2.1.7 I/we have satisfied myself/ourselves as to the correctness and validity of this bid, that the price(s) and rate(s) quoted cover all the work/items(s) specified in the bid documents and that the price(s) and rate(s) cover all my/our obligations under a resulting contract and that I/we accept that any mistakes regarding price(s) and calculations will be at my/our risk

2.1.8 I/we accept full responsibility for the proper execution and conditions defaulting on me/us under this agreement as the principal(s) liable for the fulfilment of this contract. I/we declare that I/we have participation/no participation in the submission of any other bid for the supplies/services described in the attached documents.

If your answer here is yes, please state the names(s) of the other Bid(s) involved.....

PART D:

GENERAL CONDITIONS OF CONTRACT GENERAL CONDITIONS OF CONTRACT THE NATIONAL TREASURY REPUBLIC OF SOUTH AFRICA

Government Procurement: Greater Tzaneen Municipality

General Conditions of Contract July 2010

The purpose of this document is to:

- (i) Draw special attention to certain general conditions applicable to government bids, contracts and orders; and
- (ii) (ii) To ensure that clients be familiar with regard to the rights and obligations of all parties involved in doing business with government. In this document words in the singular also mean in the plural and vice versa and words in the masculine also mean in the feminine and neuter. The General Conditions of Contract will form part of all bid documents and may not be amended. Special Conditions of Contract (SCC) relevant to a specific bid, should be compiled separately for every bid (if (applicable) and will supplement the General Conditions of Contract. Whenever there is a conflict, the provisions in the SCC shall prevail.

TABLE OF CLAUSES

- 1. Definitions
- 2. Application
- 3. General
- 4. Standards
- 5. Use of contract documents and information; inspection
- 6. Patent rights
- 7. Performance security
- 8. Inspections, tests and analysis
- 9. Packing
- 10. Delivery and documents
- 11. Insurance
- 12. Transportation
- 13. Incidental services
- 14. Spare parts
- 15. Warranty
- 16. Payment
- 17. Prices
- 18. Contract amendments
- 19. Assignment
- 20. Subcontracts
- 21. Delays in the supplier's performance

22. Penalties
23. Termination for default
24. Dumping and countervailing duties
25. Force Majeure
26. Termination for insolvency
27. Settlement of disputes
28. Limitation of liability
29. Governing language
30. Applicable law
31. Notices
32. Taxes and duties
33. National Industrial Participation Programme (NIPP)
34. Prohibition of restrictive practices

1. DEFINITIONS

The following terms shall be interpreted as indicated:

- 1.1 "Closing time" means the date and hour specified in the bidding documents for the receipt of bids.
- 1.2 "Contract" means the written agreement entered into between the purchaser and the supplier, as recorded in the contract form signed by the parties, including all attachments and appendices thereto and all documents incorporated by reference therein.
- 1.3 "Contract price" means the price payable to the supplier under the contract for the full and proper performance of his contractual obligations.
- 1.4 "Corrupt practice" means the offering, giving, receiving, or soliciting of anything of value to influence the action of a public official in the procurement process or in contract execution.
- 1.5 "Countervailing duties" are imposed in cases where an enterprise abroad is subsidized by its government and encouraged to market its products internationally.
- 1.6 "Country of origin" means the place where the goods were mined, grown or produced or from which the services are supplied. Goods are produced when, through manufacturing, processing or substantial and major assembly of components, a commercially recognized new product results that is substantially different in basic characteristics or in purpose or utility from its components.
- 1.7 "Day" means calendar day.
- 1.8 "Delivery" means delivery in compliance of the conditions of the contract or order.
- 1.9 "Delivery ex stock" means immediate delivery directly from stock actually on hand.
- 1.10 "Delivery into consignees store or to his site" means delivered and unloaded in the specified store or depot or on the specified site in compliance with the conditions of the contract or order, the supplier bearing all risks and charges involved until the supplies are so delivered and a valid receipt is obtained.
- 1.11 "Dumping" occurs when a private enterprise abroad market its goods on own initiative in the RSA at lower prices than that of the country of origin and which have the potential to harm the local industries in the RSA.
- 1.12" Force majeure" means an event beyond the control of the supplier and not involving the supplier's fault or negligence and not foreseeable. Such events may include, but is not restricted to, acts of the purchaser in its sovereign capacity, wars or revolutions, fires, floods, epidemics, quarantine restrictions and freight embargoes.
- 1.13 "Fraudulent practice" means a misrepresentation of facts in order to influence a procurement process or the execution of a contract to the detriment of any bidder, and includes collusive practice among bidders

(prior to or after bid submission) designed to establish bid prices at artificial non-competitive levels and to deprive the bidder of the benefits of free and open competition.

1.14 “GCC” means the General Conditions of Contract.

1.15 “Goods” means all of the equipment, machinery, and/or other materials that the supplier is required to supply to the purchaser under the contract.

1.16 “Imported content” means that portion of the bidding price represented by the cost of components, parts or materials which have been or are still to be imported (whether by the supplier or his subcontractors) and which costs are inclusive of the costs abroad, plus freight and other direct importation costs such as landing costs, dock dues, import duty, sales duty or other similar tax or duty at the South African place of entry as well as transportation and handling charges to the factory in the Republic where the supplies covered by the bid will be manufactured.

1.17 “Local content” means that portion of the bidding price which is not included in the imported content provided that local manufacture does take place.

1.18 “Manufacture” means the production of products in a factory using labour, materials, components and machinery and includes other related value-adding activities.

1.19 “Order” means an official written order issued for the supply of goods or works or the rendering of a service.

1.20 “Project site,” where applicable, means the place indicated in bidding documents.

1.21 “Purchaser” means the organization purchasing the goods.

1.22 “Republic” means the Republic of South Africa.

1.23 “SCC” means the Special Conditions of Contract.

1.24 “Services” means those functional services ancillary to the supply of the goods, such as transportation and any other incidental services, such as installation, commissioning, provision of technical assistance, training, catering, gardening, security, maintenance and other such obligations of the supplier covered under the contract.

1.25 “Written” or “in writing” means handwritten in ink or any form of electronic or mechanical writing.

2. APPLICATION

2.1 These general conditions are applicable to all bids, contracts and orders including bids for functional and professional services, sales, hiring, letting and the granting or acquiring of rights, but excluding immovable property, unless otherwise indicated in the bidding documents.

2.2 Where applicable, special conditions of contract are also laid down to cover specific supplies, services or works.

2.3 Where such special conditions of contract are in conflict with these general conditions, the special conditions shall apply.

3. GENERAL

3.1 Unless otherwise indicated in the bidding documents, the purchaser shall not be liable for any expense incurred in the preparation and submission of a bid. Where applicable a non-refundable fee for documents may be charged.

3.2 With certain exceptions, invitations to bid are only published in the Government Tender Bulletin. The Government Tender Bulletin may be obtained directly from the Government Printer, Private Bag X85, Pretoria 0001, or accessed electronically from www.treasury.gov.za

4. STANDARDS

4.1 The goods supplied shall conform to the standards mentioned in the bidding documents and specifications.

5. USE OF CONTRACT DOCUMENTS AND INFORMATION; INSPECTION.

5.1 The supplier shall not, without the purchaser's prior written consent, disclose the contract, or any provision thereof, or any specification, plan, drawing, pattern, sample, or information furnished by or on behalf of the purchaser in connection therewith, to any person other than a person employed by the supplier in the performance of the contract. Disclosure to any such employed person shall be made in confidence and shall extend only as far as may be necessary for purposes of such performance.

5.2 The supplier shall not, without the purchaser's prior written consent, make use of any document or information mentioned in GCC clause

5.2.1 Except for purposes of performing the contract.

5.3 Any document, other than the contract itself mentioned in GCC clause

5.3.1 Shall remain the property of the purchaser and shall be returned (all copies) to the purchaser on completion of the supplier's performance under the contract if so required by the purchaser.

5.4 The supplier shall permit the purchaser to inspect the supplier's records relating to the performance of the supplier and to have them audited by auditors appointed by the purchaser, if so required by the purchaser.

6. PATENT RIGHTS

6.1 The supplier shall indemnify the purchaser against all third-party claims of infringement of patent, trademark, or industrial design rights arising from use of the goods or any part thereof by the purchaser.

7. PERFORMANCE SECURITY

7.1 Within thirty (30) days of receipt of the notification of contract award, the successful bidder shall furnish to the purchaser the performance security of the amount specified in SCC.

7.2 The proceeds of the performance security shall be payable to the purchaser as compensation for any loss resulting from the supplier's failure to complete his obligations under the contract.

7.3 The performance security shall be denominated in the currency of the contract or in a freely convertible currency acceptable to the purchaser and shall be in one of the following forms:

(a) A bank guarantee or an irrevocable letter of credit issued by a reputable bank located in the purchaser's country or abroad, acceptable to the purchaser, in the form provided in the bidding documents or another form acceptable to the purchaser; or

(b) A cashier's or certified cheque

7.4 The performance security will be discharged by the purchaser and returned to the supplier not later than thirty (30) days following the date of completion of the supplier's performance obligations

8. INSPECTIONS, TESTS AND ANALYSES

8.1 All pre-bidding testing will be for the account of the bidder.

8.2 If it is a bid condition that supplies to be produced or services to be rendered should at any stage during production or execution or on completion be subject to inspection, the premises of the bidder or contractor shall be open, at all reasonable hours, for inspection by a representative of the Department or an organization acting on behalf of the Department.

8.3 If there are no inspection requirements indicated in the bidding documents and no mention is made in the contract, but during the contract period it is decided that inspections shall be carried out, the purchaser shall itself make the necessary arrangements, including payment arrangements with the testing authority concerned.

8.4 If the inspections, tests and analyses referred to in clauses 8.2 and 8.3 show the supplies to be in accordance with the contract requirements, the cost of the inspections, tests and analyses shall be defrayed by the purchaser.

8.5 Where the supplies or services referred to in clauses 8.2 and 8.3 do not comply with the contract requirements, irrespective of whether such supplies or services are accepted or not, the cost in connection with these inspections, tests or analyses shall be defrayed by the supplier.

8.6 Supplies and services which are referred to in clauses 8.2 and 8.3 and which do not comply with the contract requirements may be rejected.

8.7 Any contract supplies may on or after delivery be inspected, tested or analyzed and may be rejected if found not to comply with the requirements of the contract. Such rejected supplies shall be held at the cost and risk of the supplier who shall, when called upon, remove them immediately at his own cost and forthwith substitute them with supplies which do comply with the requirements of the contract. Failing such removal, the rejected supplies shall be returned at the suppliers cost and risk. Should the supplier fail to provide the substitute supplies forthwith, the purchaser may, without giving the supplier further opportunity to substitute the rejected supplies, purchase such supplies as may be necessary at the expense of the supplier.

8.8 The provisions of clauses 8.4 to 8.7 shall not prejudice the right of the purchaser to cancel the contract on account of a breach of the conditions thereof, or to act in terms of Clause 23 of GCC.

9. PACKING

9.1 The supplier shall provide such packing of the goods as is required to prevent their damage or deterioration during transit to their final destination, as indicated in the contract. The packing shall be sufficient to withstand, without limitation, rough handling during transit and exposure to extreme temperatures, salt and precipitation during transit, and open storage. Packing, case size and weights shall take into consideration, where appropriate, the remoteness of the goods' final destination and the absence of heavy handling facilities at all points in transit.

9.2 The packing, marking, and documentation within and outside the packages shall comply strictly with such special requirements as shall be expressly provided for in the contract, including additional requirements, if any, specified in SCC, and in any subsequent instructions ordered by the purchaser.

10. DELIVERY AND DOCUMENTS

10.1 Delivery of the goods shall be made by the supplier in accordance with the terms specified in the contract. The details of shipping and/or other documents to be furnished by the supplier are specified in SCC.

10.2 Documents to be submitted by the supplier are specified in SCC.

11. INSURANCE

11.1 The goods supplied under the contract shall be fully insured in a freely convertible currency against loss or damage incidental to manufacture or acquisition, transportation, storage and delivery in the manner specified in the SCC.

12. TRANSPORTATION

12.1 Should a price other than an all-inclusive delivered price be required, this shall be specified in the SCC.

13. INCIDENTAL SERVICES

13.1 The supplier may be required to provide any or all of the following services, including additional services, if any, specified in SCC:

- (a) Performance or supervision of on-site assembly and/or commissioning of the supplied goods;
- (b) Furnishing of tools required for assembly and/or maintenance of the supplied goods;
- (c) Furnishing of a detailed operations and maintenance manual for each appropriate unit of the supplied goods;
- (d) Performance or supervision or maintenance and/or repair of the supplied goods, for a period of time agreed by the parties, provided that this service shall not relieve the supplier of any warranty obligations under this contract; and
- (e) Training of the purchaser's personnel, at the supplier's plant and/or on-site, in assembly, start-up, operation, maintenance, and/or repair of the supplied goods.

13.2 Prices charged by the supplier for incidental services, if not included in the contract price for the goods, shall be agreed upon in advance by the parties and shall not exceed the prevailing rates charged to other parties by the supplier for similar services.

14. SPARE PARTS

14.1 As specified in SCC, the supplier may be required to provide any or all of the following materials, notifications, and information pertaining to spare parts manufactured or distributed by the supplier:

- (a) such spare parts as the purchaser may elect to purchase from the supplier, provided that this election shall not relieve the supplier of any warranty obligations under the contract; and
- (b) In the event of termination of production of the spare parts:
 - (i) Advance notification to the purchaser of the pending termination, in sufficient time to permit the purchaser to procure needed requirements; and
 - (ii) Following such termination, furnishing at no cost to the purchaser, the blueprints, drawings, and specifications of the spare parts, if requested.

15. WARRANTY

15.1 The supplier warrants that the goods supplied under the contract are new, unused, of the most recent or current models and those they incorporate all recent improvements in design and materials unless provided otherwise in the contract. The supplier further warrants that all goods supplied under this contract shall have

no defect, arising from design, materials, or workmanship (except when the design and/or material is required by the purchaser's specifications) or from any act or omission of the supplier, that may develop under normal use of the supplied goods in the conditions prevailing in the country of final destination.

15.2 This warranty shall remain valid for twelve (12) months after the goods, or any portion thereof as the case may be, have been delivered to and accepted at the final destination indicated in the contract, or for eighteen (18) months after the date of shipment from the port or place of loading in the source country, whichever period concludes earlier, unless specified otherwise in SCC.

15.3 The purchaser shall promptly notify the supplier in writing of any claims arising under this warranty.

15.4 Upon receipt of such notice, the supplier shall, within the period specified in SCC and with all reasonable speed, repair or replace the defective goods or parts thereof, without costs to the purchaser.

15.5 If the supplier, having been notified, fails to remedy the defect(s) within the period specified in SCC, the purchaser may proceed to take such remedial action as may be necessary, at the supplier's risk and expense and without prejudice to any other rights which the purchaser may have against the supplier under the contract.

16. PAYMENT

16.1 The method and conditions of payment to be made to the supplier under this contract shall be specified in SCC.

16.2 The supplier shall furnish the purchaser with an invoice accompanied by a copy of the delivery note and upon fulfilment of other obligations stipulated in the contract.

16.3 Payments shall be made promptly by the purchaser, but in no case later than thirty (30) days after submission of an invoice or claim by the supplier.

16.4 Payment will be made in Rand unless otherwise stipulated in SCC.

17. PRICES 17.1 Prices charged by the supplier for goods delivered and services performed under the contract shall not vary from the prices quoted by the supplier in his bid, with the exception of any price adjustments authorized in SCC or in the purchaser's request for bid validity extension, as the case may be.

18. CONTRACT AMENDMENTS

18.1 No variation in or modification of the terms of the contract shall be made except by written amendment signed by the parties concerned.

19. ASSIGNMENT

19.1 The supplier shall not assign, in whole or in part, its obligations to perform under the contract, except with the purchaser's prior written consent.

20. SUBCONTRACTS

20.1 The supplier shall notify the purchaser in writing of all subcontracts awarded under these contracts if not already specified in the bid. Such notification, in the original bid or later, shall not relieve the supplier from any liability or obligation under the contract.

21. DELAYS IN THE SUPPLIER'S PERFORMANCE

21.1 Delivery of the goods and performance of services shall be made by the supplier in accordance with the time schedule prescribed by the purchaser in the contract.

21.2 If at any time during performance of the contract, the supplier or its subcontractor(s) should encounter conditions impeding timely delivery of the goods and performance of services, the supplier shall promptly notify the purchaser in writing of the fact of the delay, its likely duration and its cause(s). As soon as practicable after receipt of the supplier's notice, the purchaser shall evaluate the situation and may at his discretion extend the supplier's time for performance, with or without the imposition of penalties, in which case the extension shall be ratified by the parties by amendment of contract.

21.3 No provision in a contract shall be deemed to prohibit the obtaining of supplies or services from a national department, provincial department, or a local authority.

21.4 The right is reserved to procure outside of the contract small quantities or to have minor essential services executed if an emergency arises, the supplier's point of supply is not situated at or near the place where the supplies are required, or the supplier's services are not readily available.

21.5 Except as provided under GCC Clause 25, a delay by the supplier in the performance of its delivery obligations shall render the supplier liable to the imposition of penalties, pursuant to GCC Clause 22, unless an extension of time is agreed upon pursuant to GCC Clause 21.2 Without the application of penalties.

21.6 Upon any delay beyond the delivery period in the case of a supplies contract, the purchaser shall, without cancelling the contract, be entitled to purchase supplies of a similar quality and up to the same quantity in substitution of the goods not supplied in conformity with the contract and to return any goods delivered later at the supplier's expense and risk, or to cancel the contract and buy such goods as may be required to complete the contract and without prejudice to his other rights, be entitled to claim damages from the supplier.

22. PENALTIES

22.1 Subject to GCC Clause 25, if the supplier fails to deliver any or all of the goods or to perform the services within the period(s) specified in the contract, the purchaser shall, without prejudice to its other remedies under the contract, deduct from the contract price, as a penalty, a sum calculated on the delivered price of the delayed goods or unperformed services using the current prime interest rate calculated for each

day of the delay until actual delivery or performance. The purchaser may also consider termination of the contract pursuant to GCC Clause 23.

23. TERMINATION FOR DEFAULT

23.1 The purchaser, without prejudice to any other remedy for breach of contract, by written notice of default sent to the supplier, may terminate this contract in whole or in part:

- (a) If the supplier fails to deliver any or all of the goods within the period(s) specified in the contract, or within any extension thereof granted by the purchaser pursuant to GCC Clause 21.2;
- (b) If the Supplier fails to perform any other obligation(s) under the contract; or
- (c) If the supplier, in the judgment of the purchaser, has engaged in corrupt or fraudulent practices in competing for or in executing the contract.

23.2 In the event the purchaser terminates the contract in whole or in part, the purchaser may procure, upon such terms and in such manner as it deems appropriate, goods, works or services similar to those undelivered, and the supplier shall be liable to the purchaser for any excess costs for such similar goods, works or services. However, the supplier shall continue performance of the contract to the extent not terminated.

23.3 Where the purchaser terminates the contract in whole or in part, the purchaser may decide to impose a restriction penalty on the supplier by prohibiting such supplier from doing business with the public sector for a period not exceeding 10 years.

23.4 If a purchaser intends imposing a restriction on a supplier or any person associated with the supplier, the supplier will be allowed a time period of not more than fourteen (14) days to provide reasons why the envisaged restriction should not be imposed. Should the supplier fail to respond within the stipulated fourteen (14) days the purchaser may regard the intended penalty as not objected against and may impose it on the supplier?

23.5 Any restriction imposed on any person by the Accounting Officer / Authority will, at the discretion of the Accounting Officer / Authority, also be applicable to any other enterprise or any partner, manager, director or other person who wholly or partly exercises or exercised or may exercise control over the enterprise of the first-mentioned person, and with which enterprise or person the first-mentioned person, is or was in the opinion of the Accounting Officer / Authority actively associated.

23.6 If a restriction is imposed, the purchaser must, within five (5) working days of such imposition, furnish the National Treasury, with the following information: (i) The name and address of the supplier and / or person restricted by the purchaser; (ii) The date of commencement of the restriction (iii) The period of restriction; and (iv) The reasons for the restriction. These details will be loaded in the National Treasury's central database of suppliers or persons prohibited from doing business with the public sector.

23.7 If a court of law convicts a person of an offence as contemplated in sections 12 or 13 of the Prevention and Combating of Corrupt Activities Act, No. 12 of 2004, the court may also rule that such person's name be endorsed on the Register for Tender Defaulters. When a person's name has been endorsed on the Register, the person will be prohibited from doing business with the public sector for a period not less than five years and not more than 10 years. The National Treasury is empowered to determine the period of restriction and each case will be dealt with on its own merits. According to section 32 of the Act the Register must be open to the public. The Register can be perused on the National Treasury website.

24. ANTI-DUMPING AND COUNTERVAILING DUTIES AND RIGHTS

24.1 When, after the date of bid, provisional payments are required, or antidumping or countervailing duties are imposed, or the amount of a provisional payment or anti-dumping or countervailing right is increased in respect of any dumped or subsidized import, the State is not liable for any amount so required or imposed, or for the amount of any such increase. When, after the said date, such a provisional payment is no longer required or any such anti-dumping or countervailing right is abolished, or where the amount of such provisional payment or any such right is reduced, any such favourable difference shall on demand be paid forthwith by the contractor to the State or the State may deduct such amounts from moneys (if any) which may otherwise be due to the contractor in regard to supplies or services which he delivered or rendered, or is to deliver or render in terms of the contract or any other contract or any other amount which may be due to him

25. FORCE MAJEURE

25.1 Notwithstanding the provisions of GCC Clauses 22 and 23, the supplier shall not be liable for forfeiture of its performance security, damages, or termination for default if and to the extent that his delay in performance or other failure to perform his obligations under the contract is the result of an event of force majeure.

25.2 If a force majeure situation arises, the supplier shall promptly notify the purchaser in writing of such condition and the cause thereof. Unless otherwise directed by the purchaser in writing, the supplier shall continue to perform its obligations under the contract as far as is reasonably practical, and shall seek all reasonable alternative means for performance not prevented by the force majeure event.

26. TERMINATION FOR INSOLVENCY

26.1 The purchaser may at any time terminate the contract by giving written notice to the supplier if the supplier becomes bankrupt or otherwise insolvent. In this event, termination will be without compensation to the supplier, provided that such termination will not prejudice or affect any right of action or remedy which has accrued or will accrue thereafter to the purchaser.

27. SETTLEMENT OF DISPUTES

27.1 If any dispute or difference of any kind whatsoever arises between the purchaser and the supplier in connection with or arising out of the contract, the parties shall make every effort to resolve amicably such dispute or difference by mutual consultation.

27.2 If, after thirty (30) days, the parties have failed to resolve their dispute or difference by such mutual consultation, then either the purchaser or the supplier may give notice to the other party of his intention to commence with mediation. No mediation in respect of this matter may be commenced unless such notice is given to the other party.

27.3 Should it not be possible to settle a dispute by means of mediation, it may be settled in a South African court of law.

27.4 Mediation proceedings shall be conducted in accordance with the rules of procedure specified in the SCC.

27.5 Notwithstanding any reference to mediation and/or court proceedings herein, (a) the parties shall continue to perform their respective obligations under the contract unless they otherwise agree; and (b) The purchaser shall pay the supplier any monies due the supplier.

28. LIMITATION OF LIABILITY

28.1 Except in cases of criminal negligence or wilful misconduct, and in the case of infringement pursuant to Clause 6;

(a) the supplier shall not be liable to the purchaser, whether in contract, tort, or otherwise, for any indirect or consequential loss or damage, loss of use, loss of production, or loss of profits or interest costs provided that this exclusion shall not apply to any obligation of the supplier to pay penalties and/or damages to the purchaser; and

(b) The aggregate liability of the supplier to the purchaser, whether under the contract, in tort or otherwise, shall not exceed the total contract price, provided that this limitation shall not apply to the cost of repairing or replacing defective equipment.

29. GOVERNING LANGUAGE

29.1 The contract shall be written in English. All correspondence and other documents pertaining to the contract that is exchanged by the parties shall also be written in English.

30. APPLICABLE LAW

30.1 The contract shall be interpreted in accordance with South African laws, unless otherwise specified in SCC.

31. NOTICES

31.1 Every written acceptance of a bid shall be posted to the supplier concerned by registered or certified mail and any other notice to him shall be posted by ordinary mail to the address furnished in his bid or to the address notified later by him in writing and such posting shall be deemed to be proper service of such notice

31.2 The time mentioned in the contract documents for performing any act after such aforesaid notice has been given, shall be reckoned from the date of posting of such notice.

32. TAXES AND DUTIES

32.1 A foreign supplier shall be entirely responsible for all taxes, stamp duties, license fees, and other such levies imposed outside the purchaser's country.

32.2 A local supplier shall be entirely responsible for all taxes, duties, license fees, etc., incurred until delivery of the contracted goods to the purchaser.

32.3 No contract shall be concluded with any bidder whose tax matters are not in order. Prior to the award of a bid the Department must be in possession of a tax clearance certificate, submitted by the bidder. This certificate must be an original issued by the South African Revenue Services.

33. NATIONAL INDUSTRIAL PARTICIPATION (NIP) PROGRAMME

33.1 The NIP Programme administered by the Department of Trade and Industry shall be applicable to all contracts that are subject to the NIP obligation.

34 PROHIBITION OF RESTRICTIVE PRACTICES

34.1 In terms of section 4 (1) (b) (iii) of the Competition Act No. 89 of 1998, as amended, an agreement between, or concerted practice by, firms, or a decision by an association of firms, is prohibited if it is between parties in a horizontal relationship and if a bidder (s) is / are or a contractor(s) was / were involved in collusive bidding (or bid rigging).

34.2 If a bidder(s) or contractor(s), based on reasonable grounds or evidence obtained by the purchaser, has / have engaged in the restrictive practice referred to above, the purchaser may refer the matter to the Competition Commission for investigation and possible imposition of administrative penalties as contemplated in the Competition Act No. 89 of 1998

PART E GENERAL PROCEDURES

1. General Directives

1. The following general procedures contained in this document have been laid down by the Council and are applicable to all bids, orders and contracts, unless otherwise approved by the Council prior to the invitation of the bids.

2. Where applicable, special conditions or procedures are also laid down by the Council to cover specific supplies or services.

3. Where such special conditions or procedures are in conflict with the general conditions and procedures, the special conditions or procedures shall apply.

4. The bidder shall satisfy himself/herself with the conditions and circumstances of the bid. By bidding, the bidder shall deem to have satisfied himself/herself as to all the conditions and circumstances of the bid.

5. Formal contract are concluded with the contractors only where this requirement is stated in the bid invitation.

6. All bids with regard to the bidding of a service e.g. materials, cleaning services; professional services, etc. shall be subject to the negotiation of a Service Level agreement between the successful contractor and the Municipality. The acceptance of this Service Level Agreement is subject to the approval by the Council of the Municipality.

7. The written acceptance of bid shall be posted to the bidder or contractor concerned by registered or certified mail.

8. Process for competitive bidding Following are procedures for a competitive bidding process for each of the following stages:

8.1 Compilation of bidding documentation

(a) Take into account – ♣ The general conditions of contract; ♣ Any Treasury guidelines on bid documentation; and ♣ The requirement of the Construction Industry Development Board, in the case of a bid relating to construction, Replacement or refurbishment of buildings or infrastructure.

(b) Include evaluation and adjudication criteria, including any criteria required by other applicable legislation.

(c) Compel bidders to declare any conflict of interest they may have in the transaction for which the bid is submitted as MBD 4

(d) Require the bidders to furnish the following if the value of the transaction is expected to exceed R10 million (VAT included):

- ♣ If the bidder is required by law to prepare annual financial statements for auditing, their audited annual financial statement – * For the past three years; or * Since their establishment if establishment during the past three years
- ♣ A certificate signed by the bidder certifying that the bidder has no undisputed commitments for municipal services towards a municipality or other service provider in respect of which payments is overdue for more than 30 days
- ♣ Particulars of any contracts awarded to the bidder by an organ of state during the past five years, including particulars of any material non-compliance or dispute concerning the execution of such contract
- ♣ A statement indicating whether any portion of the goods or services are expected to be sourced from outside the Republic, and, if so, what portion and whether any portion of payment from the municipality is expected to be transferred out of the Republic (e) Stipulate that disputes must be settled by means of mutual consultation, mediation (with or without legal representation), or, when unsuccessful, in a South African court of law.

8.2 Issuing of bid documents On the date that the advertisement appears in the Municipality's Bid Bulletin, and or media, prospective bidders may request copies of the bid documentation. The Supply Chain Unit will keep a register and potential bidders should sign for receipt of the bid documentation. If a fee is payable, an official receipt must be issued before the bid document is handed to the bidder. No bid responses from any Bidder should be accepted if sent via the Internet, e-mail or fax.

8.3 Only the Supply Chain Management Unit will have direct communication between the potential bidders and will facilitate all communication between potential bidders and the Municipality with regard to any advertised bid. No line function staff should be allowed to communicate with potential bidders without the approval by the Chief Financial Officer: Supply Chain Management Unit. The Supply Chain Management Unit will only consider request for the extension of the closing dates of advertised bid if the postponed date can be advertised in the media used to advertise before the original closing date. The closing time may be postponed only if all potential bidders can be advised of the postponed time, in writing, before the original closing time. The decision to extend the closing date or 27 time rests with the Chief Financial Officer: Supply Chain Management Unit, who must ensure compliance with all relevant rules and regulations and must confirm prior to the action being taken.

8.4 Public Invitation for competitive bids The following are procedures for the invitation of competitive bids:

- (i) Invitation to prospective providers to submit bids must be by means of a public advertisement in newspapers commonly circulating locally, the website of the municipality or any other appropriate ways (which may include an advertisement in the Government Bid Bulletin) and

(ii) Public advertisement must contain the following: The closure date for the submission of bids, which may not be less than 30 days in the case of transactions over R10 million (Vat included), or which are of a long term nature, or 14 days in any other case, from the date on which the advertisement is placed in a newspaper; subject to (iii) below; and (iii) Accounting officer may determine a closure date for the submission of bids which is less than the 30 or 14 days' requirement, but only if such shorter period can be justified on the grounds of urgency or emergency or any exceptional case where it is impractical or impossible to follow the official procurement process

(iv) Bids submitted must be sealed.

(v) The following information must appear in any advertisement:

* **Bid number,**

* **Description of the requirements**

* **Closing date and time;**

* **The name and telephone numbers of the contact person for any enquiries.**

8.5 Inspection on loco A fully explanatory site inspection will be conducted.

8.6 Handling of bids submitted in response to public invitation

(a) Closing of bids

All bids will close at **12H00** on a date as stipulated on the advertisement, which must be reflected in the bid document. Bids are late if they are received at the address indicated in the bid documents after the closing date and time. A late bid should not be admitted for consideration and where practical should be returned unopened to the bidder accompanied by and explanation.

(b) Opening of bids

Bids are opened in public as soon as possible after the closure in the presence of the Senior Supply Chain Officer: Supply Chain Management or his/her delegate. The official opening the bids should in each case read out the name of the bidder and the amount of the bid. The bid should be stamped with the official stamp of the Municipality and endorsed with the signatures of the person opening it and of the person in whose presence it was opened. Bids should be recorded in a register kept for that purpose.

8.7 Validity of the bids

The validity periods should not exceed 90 (ninety) days and is calculated from the date of bid closure endorsed on the front cover of the bid document. Should the validity period expire on a Saturday, Sunday or Public holiday, the bid must remain valid and open for acceptance until the closure on the following working date.

8.8 Consideration of bids

The Council takes all bids duly admitted into consideration. • The Council reserves the right to accept the lowest or any bid received • The decision by the Municipality regarding the awarding of a contract must be final and binding

8.9 Evaluation of bids

The following are criteria against which all bids responses will be evaluated:

- i) Compliance with bid conditions
 - ⊗ Bid submitted on time
 - ⊗ Bid forms signed and each page initialled
 - ⊗ All essential information provided
 - ⊗ Certified ID copies
 - ⊗ Proof of work experience (attach CV)
 - ⊗ Original or certified copy of B-BBEE Certificate
 - ⊗ Submission of an original Tax Clearance Certificate, MBD 2
 - ⊗ Submission of Company Registration Certificate
 - ⊗ Submission of a Joint Venture Agreement, properly signed by all parties
 - ⊗ Payment of Municipal RatesAnd all requirements as per advert

ii) Meeting technical specifications and comply with bid conditions;

iii) The number of points scored for achieving Government's Broad-Based Black Economic Empowerment objectives, points scored for price and / or points scored for functionality if applicable.

2.10 Evaluation of bids on functionality and price

- (i) Greater Tzaneen Municipality must in the bid documents indicate if, in respect of a particular bid 29 invitation that bids will be evaluated on functionality and price.
- (ii) The total combined points allowed for functionality and price may, in respect of bids with an estimated Rand value above R1, 000,000.00, not exceed 90 points.
- (iii) When evaluating bids contemplated in this item, the points for functionality must be calculated for each individual bidder
- (iv) The conditions of bid may stipulate that a bidder must score a specified minimum number of points for functionality to qualify for further adjudication.
- (v) The points for price, in respect of a bid which has scored the specified minimum number of points contemplated in sub-regulation (v) above, must, subject to the application of the

evaluation system for functionality and price contemplated in this regulation, be established separately and be calculated in accordance with the provisions of regulations c and d.

- (vi) The number of points scored for achieving Government's Broad-Based Black Economic
- (vii) Empowerment Objectives must be calculated separately and must be added to the points
- (viii) Scored for functionality and price.
- (ix) Only bid with the highest number of points be selected.

2.11 Acceptance of bids

Successful bidders must be notified at least by registered post of the acceptance of their bids, but that acceptance however, will only take effect after completion of the prescribed contract form. Unsuccessful bids should not be returned to bidders, but should be placed on record for audit purposes. A register or records should be kept of all bids accepted

2.12 Publication of bid information

The particulars of the successful bidders should be published in the Municipality's Bid Bulletin as well as the website

2.13 Cancellation and re-invitation of bids

(i) In the event that in the application of the 80/20 preference point system as stipulated in the bid documents, all bids received exceed the estimated Rand Value of R50 million, the bid invitation must be cancelled.

(ii) In the event that, in the application of the 90/10 preference point system as stipulated in the bid documents, all bids received are equal to or below R50 million, the bid must be cancelled.

(iii) In the event that the Municipality has cancelled a bid invitation as contemplated in sub regulations (i) and (ii) must re-invite bids and, must, in the bid documents stipulate the correct preference point 30 system to be applied.

(a) A bid may be cancelled before award if:

- ⊗ Due to changed circumstances, there is no longer a need for the goods, works or services offered, or
- ⊗ Funds are no longer available to cover the total envisaged expenditure, or
- ⊗ No acceptable bids were received

PART F:

BID SPECIFICATION

DETAILED SERVICE LEVEL SPECIFICATIONS

COLLECTION AND TRANSPORTATION OF (G) WASTE IN NKOWANKOWA AND BULK WASTE REMOVAL IN REGION SOUTH FOR 3 YEARS

INDEX

<u>CHAPTERS.</u>	<u>DESCRIPTION</u>
A.	General Specifications
B.	Collection & transportation specifications
C.	Pricing Instructions & Bill of Quantities
D.	Functionality requirements

A. GENERAL SPECIFICATIONS

1) AGREEMENT: -

- a) Council and the Contractor agree that Greater Tzaneen Municipality is the concerned local authority in whose area of jurisdiction Waste Management Services must be rendered
- b) Council and the Contractor agree that the rendering of Waste Management Services are an essential service which must be provided to the Greater Tzaneen Municipality.
- c) Council and the Contractor agree that Council is prepared and willing to use the appropriate Annexed Pricing Instructions to determine the contract price of the Tender
- d) Council and the Contractor agree that the all the specifications shall be the only applicable specifications in terms of the Tender
- e) Council and the Contractor agree that no other requirements or specifications will be enforceable in terms of the Tender

2) ARBITRATION

- a) Should a dispute arise between the parties and the parties to this agreement fail to resolve their differences, the dispute will be subject to arbitration, in accordance with the Arbitration Act, Act No. 42 of 1965, as amended and the parties shall in such event agree to the appointment of an arbitrator
- b) Should the parties fail to agree, regarding a dispute being of a technical nature, an appropriate qualified arbitrator recommended by the South African Institute of Waste Management, shall be requested to be the arbitrator
- c) The chairman of the Bar Council of Pretoria shall be appointed, in case of the dispute being of a legal nature
- d) The arbitration proceedings will take place at a location determined by the arbitrator and must be finalised as soon as possible
- e) The parties agree and undertake to be bound by the ruling or order of the arbitrator, which order will

be affected as directed by the arbitrator and which may be made an order of the Supreme Court of South Africa

3) GENERAL PROVISIONS

- a) Should the CONTRACTOR fail to comply with any requirement of this agreement
 - i) COUNCIL must inform him of such failure either in: -
 - (1) Writing by means of the SCORECARD-system as specified in the appropriate annexure of the specifications
 - ii) If the CONTRACTOR fail to comply with such requirement within thirty (30) days, calculated as from the date of the Council's notice
 - (1) COUNCIL shall immediately institute appropriate penalties in terms of the specifications
COUNCIL may decide, after the second failure of any specific requirement / specification, to cancel this agreement or alternatively claim specific performance by the CONTRACTOR which decision shall be in the Council's sole discretion
- b) In the event of cancellation of this agreement, the COUNCIL shall be entitled to claim compensation from the CONTRACTOR for damages suffered or may suffered as the result of the non-compliance of the CONTRACTOR with the provisions of this agreement
- c) The parties agree, by virtue of Section 45 of Act 32 of 1944, that any legal action by any party for the execution of any of his rights in accordance with this agreement be instituted in the Magistrate's Court of any district that has jurisdiction in terms of Section 28 (1) of the said Act.
- d) The COUNCIL, however, reserves the right to institute any legal action in the Supreme Court, in which case the Supreme Court's tariff of costs will be applicable
- e) The parties hereby acknowledge that this agreement constitutes the whole agreement between the parties and that no other agreement either orally or in writing has been entered into between them
 - i) Any addition or amendment to this agreement, after the signing hereof, shall not be binding or enforceable between the parties, unless the addition or amendment has been reduced to writing and signed by both parties
 - ii) In the case of any contradictory provisions between this agreement and any other documentation, the provisions of this agreement will have preference

4) PAYMENT

- a) Payment will be made by Electronic bank transfer

5) TENDER AMOUNT

- a) The tender amount will be calculated from the date as per the letter of appointment by the Accounting Officer

6) ESCALATION

- a) As per Pricing Instructions & Bill of Quantities

7) TERMINATION OF AGREEMENT BY EITHER PARTY

- a) Notwithstanding the date on which this agreement is signed the contract came in force on a date as per letter of appointment by the Accounting Officer of Greater Tzaneen Municipality for a period as determined in the Service Level Agreement, thereafter on a month-to-month basis until Tzaneen Municipality will call for new tenders
- b) After the awarding of a new tender, a month's written notice will be given to terminate this agreement
- c) This contract will terminate as follows: -
 - i) If the Contractor commit a breach of any of the terms or conditions of this agreement
 - ii) On the date of expiration as per letter of appointment

8) CANCELLATION OF PREVIOUS AGREEMENTS

- a) All previous agreements are hereby cancelled without prejudice to any rights which already accrued there under any party

9) GENERAL

- a) The tender must be addressed to the Municipal Manager, Greater Tzaneen Municipality.

10) BINDING OF CONTRACT

- a) The formal acceptance of this tender by the Council shall bind both parties

11) PRICES

- a) A net price per month (VAT inclusive) must be offered

12) COUNCIL IS NOT OBLIGED TO ACCEPT THE LOWEST OR ANY TENDER

- a) The Council is not obliged to accept the lowest or any tender and do not have to give reasons for its decision.

13) MARKING OF TENDER ENVELOPE

- a) Tender envelopes must be properly marked in accordance with the advertisement number/s.

14) SITE INSPECTION

- a) A compulsory site inspection will be held as indicated in this document.
- b) Attention is drawn to the fact that information given orally at any other time prior to the award of the Contract will not be regarded as binding on the Council, and only information given formally in writing to prospective Contractors will be regarded as amending the contract document

15) INSTITUTE OF WASTE MANAGEMENT

- a) Prospective Contractors are required to indicate whether or not their firm is a member in good standing and also how many of their employees are members of I.W.M.S.A.
- b) Membership of the Institute will be regarded as being one of the key factors when considering BIDS since this is indicative of an established interest and involvement in the waste industry.

16) CLEARANCE OF SITE ON COMPLETION

- a) Upon expiry of the Contract period, or after any extension thereto, the Contractor shall clear away and remove from the Site all plant and equipment belonging to him and leave the whole of the Site clean and in condition to the satisfaction of the Manager: Solid Waste Management

17) ADVERTISING

- a) Any advertisements erected or publicity given to the operation shall be subject to prior approval by the Manager: Solid Waste Management and to the terms of the applicable by-laws.

18) WATER SUPPLY

- a) If no water connection exists at any facilities, a connection can be supplied if desired, at a rate determined by the Greater Tzaneen Municipality

- b) The Contractor will formally have to apply and pay for such a connection at the Greater Tzaneen Municipality at the Contractors expense, with the exception of public toilets.

19) COMMENCEMENT DATE

- a) The contract shall commence on the 1st day of the month following the date of allocation of the tender and shall continue for the period as specified in the Letter of Appointment

20) PERSONAL PROTECTIVE CLOTHING

a) P.P.E. Specifications

- i) The Tenderer must ensure to comply & tender strictly in accordance with the specification requirements as per attached requirements & I.S.O. and / or S.A.B.S. certification
- ii) N.B. Contractor will be required to add the following word directly after the word “WASTE “on all printing viz: -
(1) “CONTRACTOR”

b) Descriptions for Management & T/leaders P.P.E. 's

i) Trousers

- (1) Stone khaki with two pleats // long trousers // cotton // size & inside leg measurements

ii) Shirts

- (1) Cotton bush-shirt with two top pockets // Colour: - Shirt = Stone-khaki // pockets and shoulders = nutria brown // emblem + name embroidery

iii) Belts

- (1) Leather dark brown 40mm // printed on

iv) Shoes & Socks

- (1) Smart casual // dark brown // polish // genuine leather (see example photo)
(2) Socks // step-out // thin woven {S.A.B.S.}

v) Hats

- (1) Bush cotton caps//emblem embroidery // Colour Khaki. {S.A.B.S.}

vi) Weatherproof jackets for Management & T/Leaders

- (1) JACKET 65 % cotton & 35 % polyester fiber jacket // no cap //emblem and name embroidery // stone khaki. {S.A.B.S.}
(2) Windbreaker //cap// weatherproof // towel inner // stone khaki. {S.A.B.S.}

c) Description for Snr. Labourers P.P.E. 's

i) Footwear for Labourers

- (1) White gumboots{S.A.B.S.}
(2) Bova safety shoe // no steel toe-cap // brown not-slip // light weight // cut resistant sole//{S.A.B.S.}

ii) Socks for Labourers

- (1) Wool blend // military type // absorbent. {S.A.B.S.}

iii) Hats for Labourers

- (1) Bowler bush-hats plus embroidery // Colour brilliant orange. {S.A.B.S.}

iv) Rain coats for Labourers

- (1) Two piece-yellow rubberized // Head cap {S.A.B.S.}
(2) One piece-yellow rubberized // Head cap{S.A.B.S.}

v) Overalls for Labourers

- (1) 2xTwo piece 65 % cotton & 35 % polyester fiber // brilliant orange plus printing (black on the back)// two reflective bands on both arms and both legs. {S.A.B.S.}
(2) 2xOne piece ladies overall 65 % cotton & 35 % polyester fiber// brilliant orange // below knee (black printing on the back) with two reflective band on both arms and one reflective band on waist and one on bottom {S.A.B.S.}
(3) ALL PRINTING MUST BE: -
(a) PITCH-BLACK
(b) MAXIMUM OF 50 X CHARACTERS

vi) Gloves for Labourers

- (1) Chrome leather gloves above wrists{S.A.B.S.}
(2) P.V.C. gloves above wrists// acid and cut resistant{S.A.B.S.}

vii) Safety goggles for Labourers

(1) S.A.B.S. approved

viii) Dust mask for Labourers

(1) S.A.B.S. approved.

d) Photo Gallery EXAMPLES of P.P.E. `s

i) N.B. Contractor will be required to add the following word directly after the word “WASTE” on all printing viz:

(1) “CONTRACTOR”



1) Rain coats

a) Two piece-yellow rubberized // Head cap {S.A.B.S.}

b) One piece-yellow rubberized // Head cap {S.A.B.S.}



1) Hats

a) Bowler bush-hats plus embroidery // Colour brilliant orange. {S.A.B.S.}



1) Overalls

- a) One piece ladies overall 65 % cotton & 35 % polyester fiber// brilliant orange // below knee (black printing on the back) with two reflective bands on both arms and one reflective band on waist and one on bottom. {S.A.B.S.}



1) Overalls

- a) Two piece 65 % cotton & 35 % polyester fiber // brilliant orange plus printing (black on the back)// two reflective bands on both arms and both legs. {S.A.B.S.}

1) Trousers & Shirts

- a) Trousers = stone khaki with two pleats // long trousers // cotton // size & inside leg measurements.
- b) Shirts = cotton bush-shirt with two top pockets



c) Colour: - Shirt = Stone-khaki // pockets and shoulders = Nutria brown // emblem + name embroidery.

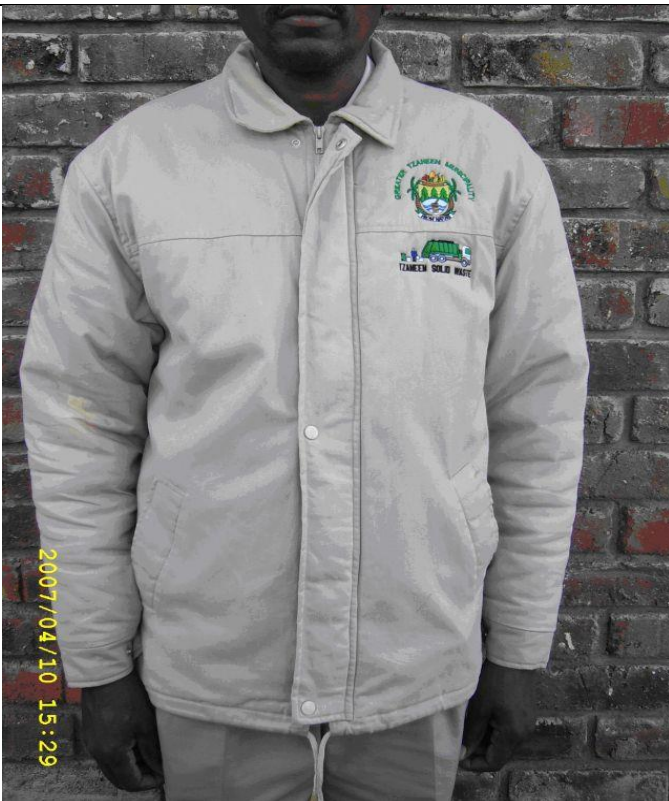

- 1) Windbreaker & Jackets
 - a) JACKET 65 % cotton & 35 % polyester fiber jacket // no cap //emblem and name embroidery // stone khaki. {S.A.B.S.}
 - b) Windbreaker // cap // weatherproof // towel inner // stone khaki. {S.A.B.S.}

- 1) Hats
 - a) Bush cotton caps // emblem embroidery // Colour Khaki. {S.A.B.S.}



1) Management

- a) Smart casual // dark brown // polish // genuine leather (see example photo)
- b) Socks // step-out // thin woven {S.A.B.S.}

2) Labour

- a) White gumboots {S.A.B.S.}
- b) Bova safety shoe // no steel toe-cap // brown not-slip // light weight // cut resistant sole // {S.A.B.S.}
- c) Socks wool blend // military type // absorbent. {S.A.B.S.}

1) Emblem

- a) Machine woven above left pocket
- b) Colour as per photo

	<p>1) <u>Belts</u> a) Leather dark brown 40mm // printed on.</p>
--	---

21) MARKING & IDENTIFICATION OF VEHICLES

- a) All vehicles must be marked & identified with appropriate stickers on both doors indicating the specific workstation/s as per undermentioned specifications

22) DEFINITIONS Unless inconsistent with or indicated otherwise by the context: -

- a) Adequate; Means acceptable in the opinion of the Employer/Head of Waste Management
- b) Approved or Approval; shall mean approved or approved by the Council's representative defined in the specification.
- c) Builder's Rubble; Pieces of masonry, concrete, etc, resulting from construction, repair and demolition operations
- d) Bulky Waste; Items such as motor car bodies, fridges, etc., who's large size precludes or complicates their handling by normal collection, processing or disposal methods
- e) C.D.W.; Mean a Community Development Worker
- f) Cell; Is a body of waste, which has been placed between berms of soil or builder's rubble, compacted and enclosed by cover material
- g) Clean; to physically remove dirt from the surface or material.
- h) Clean Greens: Compostable waste derived from garden waste (gardens and parks), which has not been mixed with other waste categories.
- i) Commercial/ Business Waste; Solid waste generated by stores, offices and other activities involved in manufacture.
- j) Compaction Density; the mass of the body of solid waste divided by the volume, after compaction occupied by that same body of waste.
- k) Compost; Organic waste that has undergone controlled microbial degradation, to produce a contamination/nuisance free product with potential value as a soil conditioner.
- l) Council; shall mean the Greater Tzaneen Municipality.
- m) Contractor; shall mean the Tenderer whose tender has been accepted by the Council and shall include the Tenderer legal personal representative, heirs, successors and assigns.

- n) Contractors Enclosure; An area allocated to the Contractor for his own use including the storage of equipment and plant
- o) Contract; Shall mean and include the Council's General Conditions of Tender; form of tender, special conditions of contract, the specifications including any schedules, drawings, patterns, samples approved by the Council's representative relative to the contract and any agreement entered into in terms of the Council's General Conditions of Tender, hereinafter referred to as "the General Conditions".
- p) Contract Price(s); shall mean the price(s) tendered by the Contractor and accepted by the Council for the execution of the contract.
- q) Cover Material; Soil or other suitable material that is used for enclosing a body of compacted waste.
- r) Cover to waste ratio; the ratio of volume of cover material to volume of compacted waste.
- s) Daily Cell; as with "cell" with the size being determined by the amount of waste disposed of in a single day.
- t) Date of delivery; shall mean the date stipulated in the contract of the delivery of the goods.
- u) Date of Tender; shall mean the date and time on which tenders are due to be deposited in terms of the advertisement calling for tenders.
- v) Delivery; shall mean delivery in compliance with the terms and conditions of the contract at the place specified in the contract.
- w) Detergent; cleansing agent used with water as a means of removing dirt and killing germs.
- x) Domestic Waste; Solid waste that originates in a residential environment.
- y) Dust; to remove dust from surfaces and using a dusting material.
- z) Employer; Means the Greater Tzaneen Municipality or its duly authorized representative.
- aa) Garden Waste; Plant clippings, pruning and other discarded material from gardens in a Municipal area.
- bb) Goods; shall mean the machinery, plant, equipment apparatus or material to be supplied under the contract.
- cc) H.o.D.; Means the Divisional Head Tzaneen Solid Waste // Municipal Waste Management Officer (M.W.M.O.) or a delegated official
- dd) Hazardous Waste; Waste, whether dry or liquid, that is potentially toxic or hazardous, and that requires special handling to avoid illness or injury to persons or damage to property
- ee) Industrial Waste; Solid waste that results from industrial processes and manufacturing.
- ff) Institutional Waste; Solid waste originating from educational, hospital, healthcare and research facilities.
- gg) Leachate; Highly contaminated aqueous liquid which results when water percolates through decomposing waste, and which may migrate from a landfill site and represent a pollution threat.
- hh) Lift; Completed layer of one cell in height and usually comprising numerous adjacent cells.

- ii) Maintenance; Means all work of repair, reconstruction, rectification required to maintain the works in accordance with the Contract
- jj) Month; shall mean a calendar month.
- kk) Operation; Means the work to be performed in accordance with the Contract
- ll) P.O.E.; Means Proof of Evidence to verify, reconcile or proof an item, specification and/or statement
- mm) Polish; To apply polish to the surface to encourage shining of such surface
- nn) S.E.T.A.; Means a Sector Education & Training Authority responsible for the setting of unit-standards for a specific working sector to ensure education & training are in compliance with education standards
- oo) Salvaging; The process of recovering any materials, gas, compost, or other matter from the waste.
- pp) Sanitary; A clean, neat and hygienic condition which won't cause a nuisance or hazard to the public health or safety.
- qq) Sanitary Landfill A method of disposing of refuse on land without causing nuisances or hazards to public health or safety, by utilizing principles to confine the refuse to the smallest practical area, to reduce it to the smallest practical volume, and to cover it with a lay of earth or other suitable material at the conclusion of each day's operations, or at such more frequent intervals as any be deemed necessary.
- rr) Sanitize; To clean sweep, wash, wipe, disinfect and sterilize any place, utensils or building equipment
- ss) Scrub; to wash the floor surface with a detergent and water solution to loosen and remove dirt using a mop, clean cloth brush or other appropriate utensil.
- tt) Site; Means the land, including structures, buildings, berms, drains, fences and the like, provided by the Employer for the purpose of the execution of the Contract.
- uu) Specification; shall mean the specification to these general instructions.
- vv) Solid Waste; Useless unwanted or discarded material with insufficient moisture content to represent free-flowing sludge or to generate free liquid
- ww) Wash; to clean with a detergent and water solution until dirt is completely removed
- xx) Wipe; to remove dirt using a clean cloth moistened in a solution of water and detergent.
- yy) Work or Works; shall mean and include goods to be provided and work to be done by the Contractor under the contract.
- zz) Writing; shall include any manuscript, type written or printed statement under or over signature or seal as the case may be.

23) COMPLETE ACCEPTANCE OF CONDITIONS

- a) The Tenderer shall be deemed to know and understand these general instructions governing tenders and the submission of a tender shall presume complete acceptance of the said instructions.
- b) The non-acceptance or variation of any of the conditions or the inclusion of any other conditions may

render the tender liable to rejection.

- c) In any contract to which there shall apply any special conditions imposed by the Council such special conditions shall be embodied in the specification relating to that contract and shall be supplementary and additional to any of the general conditions set out herein.
- d) Provided that if any such special conditions shall conflict with the general conditions, the special conditions shall apply.
- e) Subject to the provisions of the foregoing the Tenderer may qualify any one or more of the conditions but no qualification of a condition shall, if his tender be accepted, form part of his contract with the Council
- f) Unless at the time of tendering he shall have indicated in writing specifically in relation to each and every condition so qualified the number of the condition and the extent to which it is qualified.

24) ASSIGNMENT

- a) This contract is personal to the Contractor and the Contractor shall not sublet, assign or make over the contract or any part thereof, or any share of interest conditions.
- b) This clause shall not apply to sub contracts given to regular suppliers of the Contractor for materials and minor components relating to the goods supplied. The Council reserves the right to require the Contractor to submit the names of any such Contractors for its approval.

25) DISCREPANCIES

- a) Should there appear to be any discrepancies, ambiguities or want of agreement in description, dimensions, quality or quantities in the contract, the Contractor shall be obliged to refer the matter to Council's representative for decision before proceeding to execute the contract or part thereof in respect of which discrepancies, ambiguities or want of an agreement appear to exist.

26) DEFAULT

- a) Should it appear to the Council that the Contractor is not executing the contract in accordance with the true intent and meaning thereof, or that the time has expired within which delivery should have taken place or in the event of any other failure or default by the Contractor then and in any of such events
 - i) The Council may give notice in writing to the Contractor to make good the failure or default
- b) Should the Contractor fail to comply with the notice within the period specified herein then in such case the Council shall, without prejudice to any of its rights under the contract viz: -
 - i) Be at liberty forthwith to perform such work as the Contractor may have neglected to do
 - ii) Or to take the contract wholly or in part out of the Contractor's hands and order from any other person.
- c) The Contractor shall be responsible for any loss the Council may sustain by reason of such action as the Council may take in term of this clause.

27) PATENT RIGHTS

- a) The Contractor shall be deemed to warrant that no infringement of patent or other trade rights or privileges will arise from any such contract from the use by the Council of any of the articles forming the subject matter of the contract.

28) PAYMENT

- a) Unless otherwise specified in the additional or special conditions of contract, payment to the Contractor shall be made by the Council within (30) thirty days from the end of the month in which the delivery of such services have been made, provided that the Contractor shall have within such time that it is reasonably possible, rendered an invoice for payment to be effected within the aforesaid time.

29) FIRM TENDERS

- a) Tenderers may submit firm prices; which prices shall be free from all fluctuations.

30) FORMAL CONTRACT AND SURETY SHIP

- a) The Contractor shall if and when called upon to do so by the Council, enter into a formal agreement and an act of surety-ship which shall be prepared by the Council, and which shall be signed by the Contractor and, if necessary, his sureties within seven days from the date of publication that the documents are ready for signature.
- b) The costs, charges, stamp duty and other disbursement due for or in reference to the said documents shall be paid for by the Contractor.
- c) Any security called for by the Council in terms of this clause shall, however, not exceed 10 % (per cent) of the estimated total value of the contract.

31) SEQUESTRATION OR SURRENDER OF CONTRACTOR'S ESTATE

- a) In the event of
 - i) an order being made for the sequestration of the Contractor's estate, whether provisional or final
 - ii) or in the event of an application being made for such order
 - iii) or in the event of the Contractor making application for the surrender of his estate
 - iv) or if he shall enter into, make or execute any deed of assignment or other composition or arrangement with assignment of the benefit of his creditors, or purport to do so
 - v) or if the Contractor being a company, shall pass a resolution
 - vi) or if the court shall make an order for the liquidation of such company and he or the company as the case may be, shall have suffered judgment against him in a competent court
 - vii) or shall have suffered attachment of his or its movable or immovable assets in execution of a judgment
- b) Council shall have the right, summarily and without payment of any compensation to the Contractor and without prejudice to the right of the Council to sue the Contractor for any damages sustained by it in consequence of one or other of the abovementioned events.

32) PERIOD FOR WHICH TENDER HOLDS GOOD

- a) The submission to the Council of a tender shall be deemed to constitute an agreement between the Tenderer and the Council whereby such tender shall remain open for acceptance by the Council in the period specified in the tender during which period the Tenderer shall not withdraw the same or impair or derogate from its effect.

33) GENERAL

- a) The quantities of all goods offered or delivered shall be in accordance with the South African standard weights and measures.
- b) All prices shall be quoted in South African currency. Any discount or brokerage allowed to the Council must be stated in the tender document.
- c) The lowest or any tender will not necessarily be accepted and the right is reserved to accept the whole or part of any tender.
- d) Should there be any difference between the prices of particulars contained in the official form of tender and those contained in covering letter from the Tenderer, the prices and particulars contained in the official form of tender shall in all circumstances prevail.
- e) The tender, must be submitted in a sealed envelope on the official tender documents.
- f) A separate tender box is provided for the receipt of tenders and no tender will be considered which, subsequent to the closing hour of tenders, may be found in some other receptacle place.
- g) Tenders arriving after the advertised time for receiving them shall not be considered.
- h) No variation to this rule shall be allowed unless it is clear that the tender was posted in ample time to reach the Council before closing hour (time) and the Council is satisfied that the circumstances are quite exceptional and that the Tenderer had taken all reasonable precautions to allow for ordinary delay and was otherwise in no way to blame for the late arrival of the tender.
- i) All vehicle utilized for the execution of tender requirements shall be identified as follows viz: -
 - i) Stickers on both doors of each vehicle not smaller than 600 mm x 300 mm
 - ii) Pitch-black letters on brilliant orange background (stickers on both front doors) as per following example viz: -

TZANEEN SOLID WASTE CONTRACTOR
NORTHERN REGION
LITTER PICKING NO.1- TZANEEN
DO NOT LITTER- KEEP OUR TOWN CLEAN
TEL: 015-307 8310 / 015-307 8313

34) LAW TO APPLY

- a) The contract shall in all respects be construed in accordance with the law of the Republic of South Africa and any difference that may arise between the Council and the Contractor with regard to the contract shall be settled in the Republic of South Africa.
- b) The Contractor shall indemnify and keep indemnified the Employer against all losses and claims for injuries damage to any persons or property whatsoever (including surface or other damage to land or crops not being on the site suffered by tenants or occupiers) which may arise out of or in consequence of the execution of the Contract and against all claims, demands, proceedings damages, costs, charges and expenses whatsoever in respect hereof or in relation thereto.
- c) Provided always that nothing herein contained shall be deemed to render the Contractor liable for or in respect of or to indemnify the Employer against any compensation or damage for or with respect to:
 - i) The permanent use or occupation of the site or any part thereof by the Employer (save in respect of surface damage as aforesaid).
 - ii) The right of Employer to operate on, over, under in or through any land
 - iii) Interference, whether temporary or permanent, with any servitude or other right which is the unavoidable result of the operation in accordance with the Contract by the Employer
 - iv) Injuries or damage to persons or property resulting from any act or negligence done or committed during the currency of the Contract by the Employer, his agents, servants or any other Contractors (not being employed by the Contractor) for or in respect of any claims, demands proceedings, damages, costs, charges and expenses in respect thereof or in relation thereto.

35) LABOUR LEGISLATION

- a) The Contractor must ensure compliance with all Labour Laws including the following viz: -
 - i) Remuneration, salary increments and acting allowances.
 - ii) Working hours and – days.
 - iii) Overtime
 - iv) Leave arrangements
 - v) Sick leave arrangements
 - vi) Termination of service.
 - vii) Uniforms and protective clothing
 - viii) Grievance procedures
 - ix) Salary scales.
 - x) Disciplinary procedures
 - xi) Promotions, transfer and demotions
 - xii) General

36) OCCUPATIONAL HEALTH AND SAFETY LEGISLATION

a) OCCUPATIONAL HEALTH & SAFETY POLICY

- i) The Contractor shall be required at all times to adhere and act within the ambit of the occupational health and safety policy of Greater Tzaneen Municipality

b) COMMON-LAW RELATIONSHIP

- i) The Contractor agree to carry out the work in terms of the O.H.&S.-Act in order to regulate the scope of the work
- ii) The parties agree that the Contractor is an independent contractor and not an employee of the Council
- iii) The Council will under no circumstance incur vicarious liability for the acts or omissions of the Contractor or its servants nor for the acts or omissions of any sub-contractor which may be employed by the Contractor nor of the servants of such sub-contractor

c) STATUTORY RELATIONSHIP

- i) The parties agree that the Contractor is, for purposes of the work, a mandatory as defined in Section 1 of the Occupational Health and Safety Act No. 85 of 1993 (referred to below as “OHS”).

d) COMPLIANCE WITH OHS

- i) The parties hereby agree in terms of Section 37(2) of OHS to the arrangements and procedures between them to ensure compliance by the Contractor with the provisions of OHS
- ii) The Contractor undertakes to ensure that he and his sub-contractors and their respective employees will at all times comply with the requirements of OHS and, without derogating from this general undertaking, also to comply with the following: -
 - (1) The work shall be performed under the close supervision of the Contractor’s employees and the Contractor warrants that such employees are fully qualified and trained to understand the hazards associated with the work
 - (2) All employees of the Contractor and its sub-contractors will be medically fit to perform the work they are required to perform
 - (3) The Contractor shall assume full responsibility in terms of Section 16(1) of OHS. If the Contractor delegates any duty in terms of Section 16(2) a copy of such a written delegation shall immediately be forwarded to the Council
 - (4) The Contractor shall ensure that he and his supervising staff who oversee the execution of the work are fully acquainted with the requirements of OHS and that his employees, his sub-contractors and their employees fully comply with those requirements
 - (5) The Contractor shall use, for purposes of execution of the work, only competent employees who are trained on all aspects of Occupational Health and Safety pertinent to them and to the work

- (6) Discipline regarding compliance with the requirements of OHS shall be strictly enforced
- (7) Personal protective equipment shall be issued as required and worn at all material times
- (8) Safe work practices shall be enforced and all employees of the Contractor and its sub-contractors shall be made conversant with the contents of these practices
- (9) No unsafe equipment, or machinery or articles shall be used in the execution of the work
- (10) All incidents referred to in Section 24 of OHS shall be reported by the Contractor to the Department of Labour as well as to the Council. The Council shall further be provided with copies of any written documentation relating to the incident
- (11) The Council hereby obtains an interest in the issue of any formal enquiry conducted in terms of Section 32 of OHS into any incident involving the Contractor or his sub-contractor or their respective employees
- (12) No use shall be made of any Council machinery, articles, substances or equipment without prior written approval having been obtained from the Council
- (13) Work for which the issuing of a permit is required shall not be performed prior to the obtaining of the necessary valid permit
- (14) No alcohol, drug or other intoxicating substances shall be allowed on the site where the work is to be performed. Nobody suspected of being under the influence of such alcohol, drug or substance, or of having his faculties impaired for any other reason, shall be allowed on site
- (15) The Contractor shall co-operate fully with the Council and furnish to the Council or its authorized representative or agent all information reasonably requested by the latter in connection with the execution of the work and the Contractor shall fully and satisfactorily reply to all of the Council's enquiries pertinent to Occupational Health and Safety issues
- (16) The Contractor expressly agrees to comply with the procedures and arrangements required by OHS in the execution of the work
- (17) The Contractor hereby undertakes to take whatever additional steps and measures may be necessary to ensure compliance by the Contractor, its sub-contractors and their respective employees with the provisions of OHS.

e) **INSURANCE**

- i) The Contractor warrants that he is in possession of the following insurance cover which shall remain in force for the full period during which he, his sub-contractors and their respective employees are engaged in the execution of the work or for the duration of his contractual relationship with the Council, whichever period is the longest, namely
 - (1) Public liability insurance cover

(2) Any other insurance cover that will make adequate provision for any possible loss or claims arising from the acts or omissions of the Contractor, his sub-contractors or any of their respective employees.

f) COMPENSATION FOR OCCUPATIONAL INJURIES & DISEASES ACT 1993

i) The Contractor warrants that all his and all his sub-contractor's employees will be covered in terms of the provisions of the Compensation for Occupational Injuries and Diseases Act 1993 for the full duration of the work or for the duration of his contractual relationship with the Council, whichever shall be the longest.

g) DUTY TO REPORT

i) The Contractor shall be obliged to report to the Council in writing anything in relation to the work or the site where it is being executed which could reasonably be regarded as unhealthy or unsafe

ii) The Contractor undertakes for this purpose to ensure that diligent and qualified personnel will carry out inspections at reasonable intervals throughout the duration of the work

h) WARRANTY

i) The Contractor warrants that neither he nor his sub-contractors nor their respective employees shall endanger the health and safety of Council employees in any way whilst executing the work

i) REIMBURSEMENT

i) The Contractor undertakes to reimburse the Council for all medical costs incurred in relation to any of the employees of the Contractor or his sub-contractors.

j) INDEMNITY

i) The Contractor hereby indemnifies the Council against any damage, claims or losses arising out of the acts or omissions of the Contractor, his sub-contractors and any of their respective employees or agents in connection with the work or arising out of this Agreement

k) W.S.W.P. (WRITTEN SAFE WORKING PROCEDURES)

i) The Contractor will be required to comply at all times with the stipulations of the Occupational Health & Safety specifications & the following requirements viz:-

(1) Table - W.S.W.P. (Written Safe Working Procedures)

Steps	Health & Safety Hazard To Guard Against	Precautionary Measures	P.P.E.
Reporting at assembly point	<ul style="list-style-type: none"> • Liquor intoxications • Drug-abuse • Illness • Employee may result in committing errors which may cause accidents. 	<ul style="list-style-type: none"> • Team Leaders must ensure that employees under their supervision are healthy and sober minded and wearing the necessary P.P.C. 	<ul style="list-style-type: none"> • Overalls • Gloves • Boots
Transportation of employees from assembly point to point of operation to be in accordance with safety & traffic rules	<ul style="list-style-type: none"> • Disobedient of traffic rules may result in accident. • Disobedient of safety rules may also result in accident e.g. transportation of employees together with tools. 	<ul style="list-style-type: none"> • Driver must be in possession of valid driver's licence. • Enforcement of safety rules. 	
At the point of refuse collection an employee should first asses the refuse bag, bin, etc, for possible safety risk.	<ul style="list-style-type: none"> • Possible of cuts • Needle pricks • Infections. 	<ul style="list-style-type: none"> • Assess first before picking or lifting. 	<ul style="list-style-type: none"> • Safety shoes • Overalls • Cut resistant loop-pile gloves
Refuse bag/bin picking or lifting	<ul style="list-style-type: none"> • Cuts • Needle prick • Infections • Slip and falling of bags or bins • Back injury 	<ul style="list-style-type: none"> • Correct method of picking or lifting of refuse bag or load. 	<ul style="list-style-type: none"> • Loop-pile hand gloves or cut resistant gloves.
Moving to the collection vehicle	<ul style="list-style-type: none"> • Traffic accident (being hit by passing vehicles. 	<ul style="list-style-type: none"> • Be alert of moving vehicles on streets and roads. 	<ul style="list-style-type: none"> • Reflecting fish net vest • Orange overalls

Steps	Health & Safety Hazard To Guard Against	Precautionary Measures	P.P.E.
Loading g of refuse bags/bins into the collection vehicle	<ul style="list-style-type: none"> Crushing of body parts by compactor truck. 	<ul style="list-style-type: none"> Communication between the operator and other workers. 	
Transport refuse to Landfill Site	<ul style="list-style-type: none"> Slipping off refuse truck Tripping Falling Laceration by glass in refuse. 	<ul style="list-style-type: none"> Employees only in crew-cabin provided for safe standing or sitting 	
Offloading at the Landfill Site	<ul style="list-style-type: none"> Injury by tail gate Employee may be covered by refuse during offloading. 	<ul style="list-style-type: none"> Communication and ensuring that other employees are at safe distance. 	
Cleaning of truck and equipment	<ul style="list-style-type: none"> Breeding of insects. 	<ul style="list-style-type: none"> Clean once per week 	
Employees to wash themselves	<ul style="list-style-type: none"> Contaminations Infections 	<ul style="list-style-type: none"> Daily wash after work. 	

37) THE CONTRACT

- a) The Contractor agrees that with the acceptance of this Contract by the Council that the requirements & specifications as set by the Solid Waste Division shall form part of the Contract and shall be deemed to be incorporated as sections of the contract.

38) AUTHORITY TO SIGN DOCUMENTS

- a) The Contractor provide details as per Chapter 4 of person/s who is /are duly authorized to sign any form on behalf of the Tenderer by virtue of a resolution

39) CONFIRMATION OF VISIT TO THE SITE BY THE TENDERER

- a) The Contractor is required to certify as per Chapter 4 that he/she has: -
 - i) Studied the tender/contract documents thoroughly
 - ii) Examined the site and have made him- / herself familiar with all local conditions likely to influence the work and the cost thereof
 - iii) Certifies that the Tenderer is satisfied with the description of the work and perfectly understand the work to be done in the execution of this Contract.

40) SCHEDULE OF WORK SATISFACTORILY CARRIED OUT AND CURRENTLY DONE BY THE TENDERER

- a) The Contractor supply as per Chapter 4 a list of contracts of the same nature and extent that were successfully completed

41) MEMBERSHIP

- a) Proof of evidence of membership of more than 2 x years with I.W.M.S.A. (Institute of Waste Management of South Africa.) are required as per Chapter 4

42) JOB-DESCRIPTIONS & QUALIFICATIONS

- a) It is required that the incumbents of all position i.t.o. of the required organizational layout shall at all times comply with the requirements of the attached J.D. 's as require in Chapter 2 of this Service Level Specifications

43) PENALTIES FOR DEVIATIONS

- a) The events or requirements for which penalties shall be applied as per deviations of all relevant Annexures and the corresponding amounts of the penalties are as follows viz: -
- i) Failure by the Contractor to open or to operate effectively all or some tender conditions on any of the operating days viz: -
 - ★ R7,000-00 for the first occurrence, escalating by R7,000-00 for each further occurrence to a maximum of R 20,000-00 per occurrence monthly
 - ii) Failure by the Contractor to provide personnel as per organizational layout to operate on any of the operating days viz: -
 - ★ R3,000-00 for the first hour or part thereof, escalating by R3,000-00 for each further one-hour period or part thereof to a maximum of R 20,000-00 per occurrence monthly
 - iii) Any proven deviations from the operating conditions viz: -
 - ★ R7,000-00 for the first occurrence, escalating by R7,000-00 for each further occurrence to a maximum of R20,000-00 per occurrence monthly
 - iv) Unacceptable attendance to complaints from the public to the Municipality within 6 x hours of occurrence.
 - ★ R7,000-00 for the first occurrence, escalating by R7,000-00 for each further occurrence to a maximum of R20,000-00 per occurrence monthly
 - v) Should the Contractor not comply after the third penalty imposed for the same requirement not met, he will make himself liable to the termination of the contract

44) MEETINGS AND SITE INSPECTIONS

- a) During the execution of the Contract, the **CONTRACTOR** and the Manager of Waste Management shall meet at approximately monthly intervals, arrangements for the meeting being made by The Municipality or his delegate/s
- b) The Contractor shall ensure that a member of his staff, who is sufficiently senior to be able make

commitments, as well as being familiar with the operations, is always in attendance at these meetings.

- c) The meetings will be held to discuss all and any matters relating to the operation of the works, and to update and review the overall plan of operation.
- d) Decisions made, minuted and agreed at these meetings will be binding on the parties

45) **PERSONNEL, PLANT, EQUIPMENT AND LIABILITIES.**

a) Contractor's Personnel

- i) The Contractor shall be guided by applicable labour legislation, and established protocols for the sourcing of local labour or otherwise, source and provide for the engagement of all Labour, local or otherwise and, for the transport, housing, subsistence and payment thereof.
- ii) He shall employ in and about the execution of the Contract only such persons as are careful, competent and efficient in their several trades and calling
- iii) The Municipality shall be at liberty to object to and require the Contractor to remove any person who, in the opinion of the Municipality, himself is incompetent or negligent in the proper performance of his duties and such person shall not be again be employed and work on this contract without proof of having acquired the necessary skills or capacity building programme. Such information will be submitted to the Manager: Solid Waste Management.
- iv) The Contractor shall submit with his tender, a description of his proposed staff complement, including the CV's and job descriptions of key personnel.
- v) The minimum daily rate paid to general workers cannot be less than the minimum wage rate as specified in the Ministerial Determination for EPWP. The minimum wage rate should be adjusted accordingly on an annual basis.
- vi) The contractor will ensure that all the projects are branded; profiled and comply with the EPWP Corporate Identity (CI) Manual as provided by Department of Public Works.
- vii) The Contractor shall submit with his tender, a description of his proposed staff complement, including the CV's and job descriptions of key personnel.

b) Labour Returns

- i) The Contractor shall, from time to time as required by The Municipality, deliver at his office a return in detail, in such form and at such intervals as the Manager: Solid Waste Management may prescribe, showing the supervisory staff and the numbers of the several classes of Labour employed by the Contractor.

c) Plant and Equipment

- i) The Contractor shall supply all plant and equipment required for the execution of the Contract and it will be his responsibility to ensure that such plant and equipment are adequate in all respects to ensure compliance with the terms and conditions of the Contract.
- ii) The Contractor shall submit with the tender, a description of the plant complement that is proposed to be used in carrying out the action plan as detailed in the BID document.

- iii) All plant provided by the Contractor shall, be deemed to be exclusively intended for the execution of the works, and the Contractor shall not remove the same or any part thereof without the written consent of the Council.
 - iv) The Contractor shall notify the Council in writing of all hired, hire purchased and leased plant and the name and address of the owner thereof.
 - v) **The Contractor shall provide 2x tipper truck, a front end loader (TLB) and 2x 11cube REL trucks on standby for the use when required to do so at a rate indicated in the bill of quantities. The trucks should be able to lift bulk bins as well.**
- d) Public Liability Insurance
- i) The Contractor shall insure in the joint names of the Contractor and Employer against any damage, loss or injury which may occur to any property or to any person by or arising out of the carrying out of the Contract.
 - ii) Such insurance shall be affected with an insurer and in terms approved by the Employer (which approval shall not be unreasonably withheld) and for at least the amount of
 - iii) R2, 000,000-00 (two million Rand) per event, and the Contractor shall, when required, produce to the Employer or the Manager: Solid Waste Management the policy or policies of insurance and the receipts from payment of the current premiums.
 - iv) In addition to any statutory obligations, the Contractor shall report to the Manager: Solid Waste Management every accident within 24 hours of its occurrence, whether such accident is in respect of damage to persons, property or things.
 - v) If required by the Manager: Solid Waste Management, the report shall be in writing and shall contain full details of the occurrence.
 - vi) The Manager: Solid Waste Management shall have the right to make all and any enquiries either on the site or elsewhere as to the cause and results of any such accident and the Contractor shall give the Manager: Solid Waste Management full facilities for carrying out such enquiries.
- e) Accident or injury to Workmen
- i) The Council shall not be liable for or in respect of any damages or compensation payable at Law in respect or in consequence of any accident or injury to any workmen or other person in the employment of the Contractor.
 - ii) The Contractor shall indemnify and keep indemnified the Council against all such damages and compensation and against all claims, demands, proceedings, costs, charges and expenses whatsoever in respect thereof or in relation thereto.
 - iii) The Contractor shall ensure that the Letter of Good Standing from the Department of Employment and Labour remains in good standing for the duration of the contract.
- f) Insurance against Accident etc. to Workmen
- i) The Contractor shall insure against such liability with an insurer approved by the Council and

shall continue such insurance during the whole of the time that any persons are employed by him and shall, when required, produce to the Council such policy of insurance and the receipt for payment of the current premium

46) CARE OF THE SITE

- a) The Contractor shall take full responsibility for the Site or any portions thereof until expiry of the Contract period and any damage or loss from any cause whatsoever (except the "excepted defaults (RISKS) " as defined below) shall be made good at the cost of the Contractor to the satisfaction of the Municipal Waste Management Officer
- b) The "excepted defaults (RISKS) " are:
 - i) War, hostilities (whether war be declared or not), invasion, political riot, act of foreign enemies, rebellion, revolution, insurrection or military or usurped power, civil war (unless solely restricted to employees of the Contractor or of his Sub-Contractor arising from the conduct of the contract
egg. viz: -
 - (1) Riot
 - (2) Commotion
 - (3) Disorder
 - (4) Use or occupation by the Employer of any part of the Site
 - ii) National and /or regional Labour unrest to such a extent that the national and/or regional retail logistics of materials and equipment are being hindered
 - iii) Ionizing radiation or contamination by radioactivity from any nuclear fuel or from nuclear waste from the combustion of nuclear fuel, radioactive, toxic, explosion, or other hazardous properties of any explosive, nuclear assembly or nuclear component thereof.
 - iv) Pressure waves cause by aircraft or other aerial devices travelling at sonic or supersonic speeds
 - v) Abnormal nature disasters or any other abnormal situation egg.
 - (1) Veldt-fires
 - (2) Rain
 - (3) Snow
 - (4) Wind
 - (5) etc.
 - vi) Any occurrences that an experienced Contractor could not foresee, or if foreseeable and having informed the Municipal Waste Management Officer accordingly, could not reasonably make provision for or insure against

47) DOMCILIUM CITANDI ET EXECUTANDI

- a) The parties hereby choose the following as their addresses for any notices in view of this and as their domicilium citandi et executandi as follows viz: -

THE COUNCIL: -

GREATER TZANEEN MUNICIPALITY

CIVIC CENTRE

AGATHA STREET

P.O.BOX 24

TZANEEN

0850

THE CONTRACTOR

B. KERBSIDE COLLECTIONS @ NKOWANKOWA & SUB-REGIONAL BULK-SERVICES SPECIFICATIONS

1) OPERATIONS OF KERBSIDE REMOVAL SERVICE

a) Detail of Service Area

i) Maps of the areas to be serviced are attached as follows viz: -

- (1) Nkowankowa including other Waste Service areas as per details in sketch-maps; table-descriptions & other descriptions

b) Removal Schedules

i) Domestic waste: -

- (1) Refuse must be removed from each and every premise on a weekly basis
- (2) Removal maps are attached indicating the specific day of removal for a specific area.

ii) Business waste: -

- (1) Refuse must be removed from each and every premise on a daily basis from Mondays to Saturdays
- (2) Removal maps are attached indicating the specific day of removal for a specific area.

iii) Industrial waste: -

- (1) Refuse must be removed from each and every premises 3 x per week.
- (2) Removal maps are attached indicating the specific day of removal for a specific area.

iv) Bulk waste

- (1) Urban premises: -

- (a) At least 1 x per week or daily as required: -
 - (i) Recyclables to an approved ‘‘ Recycling-Centre’’
 - (ii) General waste to Tzaneen Landfill site
- (2) Rural D.o.C. removals: -
 - (a) ON CALL per day OR at least 1 x per week as required: -
 - (i) Recyclables to an approved ‘‘ Recycling-Centre’’ on a weekly basis
 - (ii) General (G)-waste to Tzaneen Landfill site on a daily basis
 - (b) No Skips are allowed to overflow at any given time
- (3) Urban D.o.C. removals
 - (a) At least 1 x per week or daily as required: -
 - (i) Recyclables to an approved ‘‘ Recycling-Centre’’ on a weekly basis
 - (ii) General(G)-waste to Tzaneen Landfill site on a daily basis
 - (b) No Skips are allowed to overflow at any given time
- c) Time frames for operations
 - i) Domestic waste
 - (1) Operations to start not earlier than 07:00 and not later than 18:00
 - (2) Operations must be conducted from Mondays to Fridays on a weekly schedule
 - ii) Business waste
 - (1) Operations to start not earlier than 07:00 and not later than 18:00
 - (2) Operations must be conducted on a weekly basis from Monday to Saturday on a weekly schedule
 - iii) Industrial waste
 - (1) Operations to start not earlier than 07:00 and not later than 18:00
 - (2) Operations must be conducted on a weekly basis as follows
 - (a) 3 x per week on Mondays, Wednesdays & Fridays
 - (b) 3 x per week on Tuesdays, Thursdays & Saturdays
 - iv) Bulk waste
 - (1) Bulk removal operations
 - (a) To start not earlier than 06:00 and not later than 18:00
 - (b) Removal schedules for each day indicating loading points for every premises are attached, and will be reconciled as & when the need arise
 - (c) Refuse collection will be allowed on Sundays
 - (d) Emergency & un-scheduled removals must be also being executed on Sundays
 - (e) Operations must be conducted strictly in accordance with specifications & requirements.

(2) Bulk route chart

- (a) Removal schedules for compactable, non-compactable & rural waste from Mondays to Saturdays as per attachment must be adhered to
- (b) The Solid Waste Manager / Delegate will be allowed to re-design route sheets for an effective; efficient and smooth removal-system, and the Contractor must adhere to such revised route-plans.
- (c) The Contractor shall on the day of removal, clean the area where the skip/bulk container is placed on the instance of removal.

(3) Bulk measurement

(a) Method, types and quantities.

- (i) Proper records shall be kept on a form or apparatus required by the Divisional Head Waste Management

- 1. Type & category
- 2. Volumes

- (b) The Contractor shall keep proper record of the type and m³ refuse removed
- (c) The Contractor shall keep proper records & tracking of the 6m³ refuse containers
- (d) Records shall be reconciled and handed over to the Manager: Tzaneen Solid Waste on the last day of each calendar month
- (e) For the measurement the Contractor must make use of a 4 x copy duplication P.o.D. (Way-bill) system as follows viz: -
 - (i) 1 x copy to the premises // user
 - (ii) 1 x copy to the Council for payment to the Contractor
 - (iii) 1 x copy to the Recycler
 - (iv) 1 x copy for Contractors own use

d) Reconciliation and record keeping

- i) Averages of volumes shall be reconciled on the last day of every calendar month and be handed over to Head of Waste Management for capturing
- ii) The attached form of measurement, or other apparatus as required, must be used for capturing of records
- iii) Duplicate records must be kept by the Contractor

e) Animal Carcasses

- i) The contractor must remove all animal carcasses on a daily basis from premises, sidewalks, streets, empty premises, etc. to the Landfill Site

f) Condition of plant

- i) All plant used shall be suitable for the application and in good working condition, and shall be so designed and constructed as to cause a minimum of dust, noise and air pollution
- ii) Properly qualified and experienced operators shall operate the plant.
- iii) In the event of a breakdown occurring, the Contractor shall be capable of calling upon such back-up plant as is necessary to ensure that the proper operation and maintenance is not placed in

jeopardy

- iv) The Contractor shall submit with his Tender, a description of his proposed plant complement, as well as a description of his back-up or breakdown and workshop facilities
 - g) Source of waste
 - i) The waste collected and removed originates from: -
 - (1) Nkowankowa as per Annexures 1-3
 - (a) Extensions A-C
 - (b) Dan Extension
 - (c) Drop-of-Centers at: -
 - (i) Nkowankowa (Placement of at least 6 x 6m³ Skips)
 - (ii) Lenyenye (Placement of at least 4 x 6m³ Skips)
 - (iii) Letsitele (Placement of at least 4 x 6m³ Skips)
 - (iv) Rural Waste Service Area Drop-of-Centers as per Annexure 4 "LOCALITY SKETCH-PLAN"
 - h) Charges for removal
 - i) The Contractor shall not charge any users for the removal of waste
 - ii) Users will be charged by the Council in terms of information supplied by the Contractor as per Tell sheet
 - i) Salvage rights
 - i) No salvaging will be allowed.
 - ii) The Contractors must enforce measures to prevent salvaging on sidewalks and other municipal property
 - iii) Salvaging can be allowed on private premises
 - j) Waste deposition
 - i) Domestic, Business & Industrial waste must be deposited at the Tzaneen Landfill Site on a daily basis
 - ii) The Tzaneen Landfill Site is situated 2.5 km south of Tzaneen along Agatha road
 - iii) Other refuse must be disposed of in accordance with appropriate legislation
- 2) OPERATIONS OF BULK REMOVALS
 - a) Detail of service area: -
 - i) The Tenderer must obtain appropriate maps at own cost e.g. Locality-maps etc.
 - ii) Waste must be collected, and the following areas be serviced with 6 x m³ skip-containers viz: -
 - (1) Urban premises
 - (2) D.o.C.s (Drop-of-Centers) in rural areas
 - (3) D.o.C.s (Drop-of-Centers) in urban areas
 - b) General Description
 - i) For urban areas a minimum of 130 x Skip-containers must be available @ the commencement date, to be deployed @ the following suburbs: -
 - (1) Nkowankowa
 - (2) Lenyenye
 - (3) Letsitele
 - c) For the rural D.o.C.s a ***MINIMUM*** of about ±66 x Skip-containers must be supplied by Contractor @ the commencement date for placement @ the following locations viz: -
 - i) **Lesedi Cluster:** - The Following D.o.C.s @ schools must be PROVIDED with 1 x skip
 - (1) Mariveni
 - (2) Mathani
 - (3) Mogoboya
 - (4) Ponani
 - (5) Lephephane
 - (6) Punch
 - (7) Rasemane
 - (8) Khujwana
 - (9) Thabeng

- (10) Leseka
- (11) Mokhapa
- (12) Seboye
- (13) Serurubele
- (14) Nkowankowa
- (15) Marget Shill
- (16) Magoza
- (17) Masungulo
- (18) Tito mboweni
- (19) Phusela
- (20) Mogabe
- (21) Mavumba
- (22) Shikhati
- (23) Joseph Mae

ii) **Bulamahlo Cluster:** - The Following D.o.C.s @ schools must be PROVIDED with 1 x skip

- (1) Dumela High School
- (2) Marovoni
- (3) Mamosala Secondary School
- (4) Gabaza Primary School
- (5) Mbangwa Primary School
- (6) Rhulani Primary School
- (7) Semana
- (8) Mhangweni
- (9) Mabushe
- (10) Lebitso
- (11) Bessie M
- (12) Professor
- (13) Tinghitsi
- (14) Myakayaka
- (15) Xivodze
- (16) Petanenge
- (17) Scotch M
- (18) Hovheni
- (19) Maponya
- (20) Timangeni
- (21) Ntwanano
- (22) Mmaphai
- (23) Mohludume
- (24) Mafutshane
- (25) Mholaba
- (26) Pherehla

d) For urban D.o.C.s a minimum of 12 x Skip-containers must be available @ the commencement date, to be deployed @ the following D.o.C.s: -

- i) Nkowankowa D.o.C.
 - (1) 4 x permanent skips
- ii) Letsitele D.o.C.
 - (1) 4 x permanent skips
- iii) Lenyenye D.o.C.
 - (1) 4 x permanent skips

e) Operations

i) Container provision

(1) Contractor`s responsibility

(a) Skip-containers provision by the Contractor, must be available at the commencement date as follows viz: -

(i) 130 x Skips @ Urban premises

(ii) 12 x Skips @ Urban D.o.C.s

(iii) 76 x Skips @ Urban D.o.C.s on request by the Head of Waste Management

(b) The Contractor must be able to provide (monthly as per instruction from the Solid Waste Manager // Delegate) an additional 10 x skips as and when required

(c) Branding of Contractor`s skips as follows: -

(i) Colour = BRILLIANT ORANGE

(ii) Branding as follows viz: -

**SOLID WASTE CONTRACTOR FOR
TZANEEN MUNICIPALITY
DO NOT LITTER- KEEP OUR TOWN CLEAN**

f) Removal frequency

i) Urban premises-skip removals: -

(1) At least 1 x per week or daily as required: -

(a) Recyclables to an approved ‘‘ Recycling-Centre’’

(b) General waste to Tzaneen Landfill site

ii) Rural D.o.C. removals: -

(1) ON CALL per day OR at least 1 x per week as required: -

(a) Recyclables to an approved ‘‘ Recycling-Centre’’ on a weekly basis

(b) General (G)-waste to Tzaneen Landfill site on a daily basis

(2) No Skips are allowed to overflow at any given time.

(3) On day of removal, the area around the skip must be cleaned.

iii) Urban D.o.C. removals

(1) At least 1 x per week or daily as required: -

(a) Recyclables to an approved ‘‘ Recycling-Centre’’ on a weekly basis

(b) General(G)-waste to Tzaneen Landfill site on a daily basis

(2) No Skips are allowed to overflow at any given time

g) Recycling

i) Tzaneen Landfill shall not receive any recyclables from D.o.C.s & the following commodities won't be allowed on the Landfill site: -

- (1) Paper & -products
 - (2) Plastics & -products
 - (3) Iron / tin and metal
 - (4) Glass & -products
- h) Waste deposition
- i) All (G) Waste must be deposited at the Tzaneen Landfill-site, provided that no recyclables shall be received and or deposited at the said Landfill
 - ii) All recyclables must be deposited at an approved Recycling-Contractor, as prescribed by the Manager // Delegate
- i) Payments
- i) Payments to the Contractor and collection of bulk-tariffs will be handled by the Greater Tzaneen Municipality
 - ii) The approved charges of Greater Tzaneen Municipality will be applied in such instances
 - iii) The Contractor shall not charge USERS for removal services
 - iv) Council shall pay the Contractor for the removal service as per tender proposal contained in the application for “bulk-removals”
 - v) Users will be charged by the Municipality in terms of information supplied by the Contractor to Tzaneen Solid Waste by means of a prior approved ‘ Waybill document System’
- j) Time frames
- i) Removal operations to start not earlier than 06:00 and not later than 18:00
 - ii) Removal schedules for each day indicating loading points for every premises are attached, AND WILL BE RECONCILED AS & WHEN THE NEED ARISE
 - iii) Refuse collection will be allowed on Sundays
 - iv) Emergency & un-scheduled removals must also be executed on Sundays
 - v) Operations must be conducted strictly in accordance with specifications & requirements
- k) Route chart
- i) Removal schedules for compactable, non-compactable & rural waste from Mondays to Saturdays as per attachment must be adhered to
 - ii) The Solid Waste Manager // Delegate will be allowed to re-design route sheets for an effective; efficient and smooth removal-system, and the Contractor must adhere to such revised route-plans
- l) Measurement
- i) The Contractor shall keep proper record of the type and m³ refuse removed
 - ii) The Contractor shall keep proper records & tracking of the 6m³ refuse containers
 - iii) Records shall be reconciled and handed over to the Manager: Tzaneen Solid Waste **on the last day of each calendar month**
 - iv) For the measurement the Contractor must make use of a 4 x copy duplication way-bill system as

follows viz: -

- (1) 1 x copy to the premises // user
- (2) 1 x copy to the Council for payment to the Contractor
- (3) 1 x copy to the Recycler
- (4) 1 x copy for Contractors own use

m) Condition of plant

- i) All plant used shall be suitable for the application and in good working condition
- ii) Shall be so designed and constructed as to cause a minimum of dust, noise and air pollution
- iii) Properly qualified and experienced operators shall operate the plant
- iv) In the event of a breakdown occurring, the Contractor shall be capable of calling upon such back-up plant as is necessary to ensure that the proper operation and maintenance is not placed in jeopardy
- v) The Contractor shall submit with his Tender, a description of his proposed plant complement, as well as a description of his back-up or breakdown and workshop facilities

n) Container specifications

- i) Containers shall be dual purpose (R.E.L. + Skip) 6 x m³ steel skip-containers
- ii) Appropriate containers for **putrid-active** commodities must be available on request by the Divisional Head Tzaneen Solid Waste
- iii) All plant used shall be suitable for the application and in good working condition and shall be so designed and constructed as to cause a minimum of dust, noise and air pollution
- iv) Properly qualified and experienced operators shall operate the plant
- v) The Contractor shall submit with his Tender a description of his proposed plant complement, as well as a description of his back-up or breakdown and workshop facilities
- vi) Excessive noisy vehicles or those with excessive exhaust gases will not be accepted by the municipality
- vii) All vehicles shall be kept clean and tidy at all times when engage in the refuse collection process
- viii) The vehicles shall have facilities for the safe transport of employees engage in refuse collection

MINIMUM REQUIREMENTS FOR 6 M³ R.E.L. CONTAINER

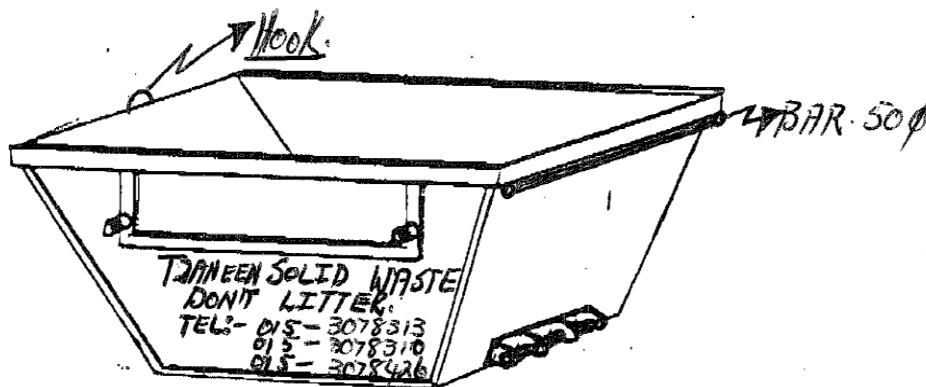
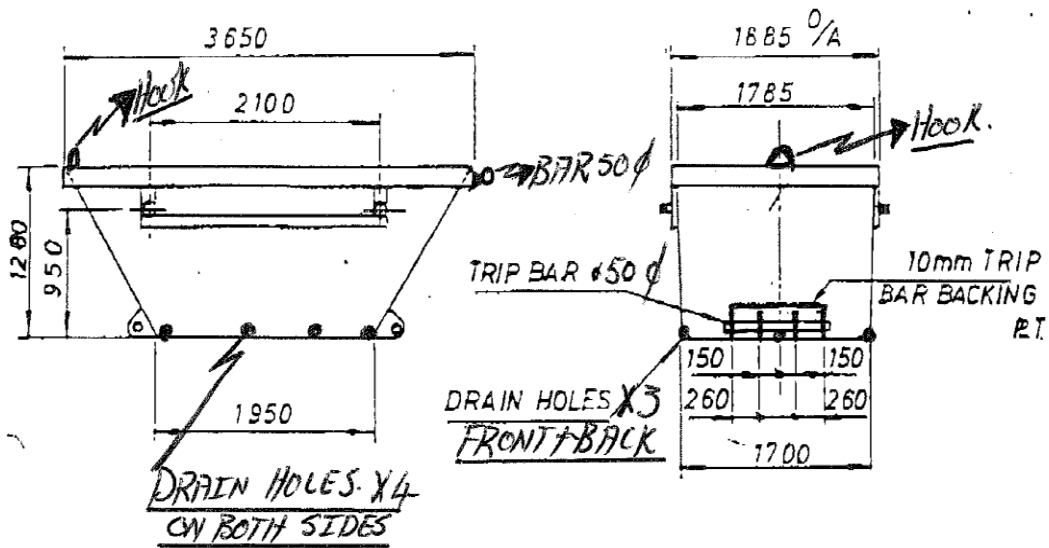

SPECIFICATION

- 1 MATERIAL : 4.5 MS.P.T.
- 2 FOLDED CORNERS & EDGES.
- 3 FULL STRENGTHENING + CORRUGATED SPACE WELDED. FLOOR.
- 4 CONTAINERS NUMBERED.
- PAINT
- 1 PRIME PAINT THROUGHOUT
- 2 FINISH PAINT OUTER SURFACES ONLY.
3. COLOUR = BRILLIANT ORANGE

SIGN WRITING ON SIDES

1. SIDE ①

1) TZANEEN SOLID WASTE
DON'T LITTER.

TEL: 015-3078310
015-3078313
015-3078426.

- o) Salvaging of refuse
 - i) No salvaging will be allowed on sidewalks/pavements
 - ii) The Contractors must enforce measures to prevent salvaging at the collection points
 - iii) Salvaging can be allowed on private premises
- p) Removal of mass container refuse and deposition of waste
 - i) All containers as utilized in the Greater Tzaneen Municipal area must be removed according to

the removal schedules or as required by the Divisional Tzaneen Solid Waste & deposited as required

- ii) All entrance-gates, at all premises, utilized by the Contractor for collection purposes shall be properly closed after completion of tasks
 - iii) Any fuel or oil spilled on any public or private road / s by the contractor's plant shall immediately be cleared & be rehabilitated by an approved Hazmat-Contractor
 - iv) Any damage to property shall be appropriately repaired within seven (7) days
 - v) Collection shall take place with a minimum of noise generation at all times
 - vi) All refuse spilled by the Contractor during operations shall be immediately cleared-up to the satisfaction of the requirements of the Health Act
 - vii) The Contractor shall ensure minimum disturbance to pedestrians and vehicles during the collection process
 - viii) The Contractor shall during operations take all necessary steps to ensure the safety of: -
 - (1) Municipal property
 - (2) Municipality's employees
 - (3) The general public
 - (4) Own employees
 - ix) The Contractor will ensure that no waste is spilled
 - (1) During loading processes
 - (2) Transportation of waste
 - x) Open container must be covered with a cargo-net during transportation
- q) Operations of URBAN D.o.C.s
- i) General
 - (1) The Contractor shall maintain all aspects of the site in order to ensure its smooth and efficient operation and prevent undue deterioration of any item
 - (2) The Contractor shall bear all maintenance costs other than the cost of materials required as a result of normal wear and tear
 - (3) Should it at any stage be evident that a large repair has resulted because the Contractor did not take action at an earlier stage, and that the Contractor has no good reason for not having taken earlier action, the cost of that repair will be for the Contractor's account
 - (4) In maintaining the site, the Contractor will be expected to perform operational maintenance work on his own initiative, but will not be liable for repairs & maintenance of CAPEX items but must report such requests in writing to the Divisional Manager
 - (5) The Contractor shall take full responsibility for the site or any portions thereof until expiration of the Contract period
 - (6) Any damage or loss from any cause whatsoever (except the risks as defined below) shall be

made good at the cost of the Contractor to the satisfaction of the Manager: Solid Waste Management (“excepted risks”) viz:-

- (a) War, hostilities (whether war be declared or not), invasion, riot, act of foreign enemies, rebellion, revolution, insurrection or military or usurped power, civil war, or unless solely restricted to employees of the Contractor or of his Sub-Contractor and arising from the conduct of the Contract, riot, commotion or disorder, or use or occupation by the Employer of any part of the site.
- (b) Ionizing radiation or contamination by radioactivity from any nuclear fuel or from nuclear waste from the combustion of nuclear fuel, radioactive, toxic, explosion, or other hazardous properties of any explosive, nuclear assembly or nuclear component thereof
- (c) Pressure waves cause by aircraft or other aerial devices traveling at sonic or supersonic speed
- (d) Any occurrences that an experienced Contractor could not foresee, or if foreseeable and having informed the Manager: Solid Waste Management according, could not reasonably make provision for or insure against

ii) Indemnification

- (1) The Contractor shall indemnify and keep indemnified the Employer against all loses and claims for injuries damage to any persons or property whatsoever (including surface or other damage to land or crops not being on the Site suffered by tenants or occupiers) which may arise out of or in consequence of the execution of the Contract and against all claims, demands, proceedings damages, costs, charges and expenses whatsoever in respect hereof or in relation thereto.
- (2) Provided always that nothing herein contained shall be deemed to render the Contractor liable for or in respect of or to indemnify the Employer against any compensation or damage for or with respect to: -
 - (a) The right of the Employer to operate on, over, under in or through any land.
 - (b) Interference, whether temporary or permanent, with any servitude or other right which is the unavoidable result of the operation in accordance with the Contract.
 - (c) Injuries or damage to persons or property resulting from any act or negligence done or committed during the currency of the Contract by the Employer, his agents, servants or any other Contractors (not being employed by the Contractor) for or in respect of any claims, demands proceedings, damages, costs, charges and expenses in respect thereof or in relation thereto

iii) Recycling

- (1) All refuse received from the D.o.C.s must be must be subjected to recycling & separation @

source as follows viz: -

- (a) Paper & cartons
 - (b) Plastic commodities
 - (c) Firewood
 - (d) E-Waste
 - (e) Metal & Tins
 - (f) Glass
- (2) It must be removed on a daily basis to the Recycling-depot / s & to Tzaneen Landfill Site respectively
 - (3) Scavenging is not allowed but sorting or recovery must be done as part of this contract on site under controlled conditions and the Contractor will be required to adhere to: -
 - (a) All appropriate laws & guidelines
 - (b) Environmental audit requirements
 - (4) A specific position for the recycling must be indicated by the Contractor.
 - (5) The Contractor will be fully responsible for the control of the recycling and the removal of the recyclables on a regular basis
 - (6) Fire is not allowed at D.o.C.s

iv) Measurement

- (1) All waste received on site shall be measured and controlled in terms of both vehicle capacity and percentage of full load, in units of m³
- (2) The Contractor shall ensure that every incoming vehicle load is checked and an accurate determination of its capacity and an estimate of the percentage of full load is made and documented when entering the site
- (3) Reconciled measuring documentation must be handed in at the Divisional Waste Manager at the last day of each calendar month
- (4) Measuring documentation // apparatus must be approved by the Divisional Waste Manager

v) Charges for disposal

- (1) The Contractor shall not charge any user
- (2) Users will be charged by Council according to information supplied by the Contractor.

vi) Operating hours

- (1) The urban D.o.C.s must be open for public offloading purposes from Mondays to Sundays (Including Public Holidays)
- (2) The urban D.o.C.s must be open and operational from 07: 00 to 18:00.
- (3) The site may not be opened outside operating hours.

vii) Gate Control and Security

- (1) For the full duration of the Contract, the Contractor shall provide a competent and reliable

gatekeeper, for the purpose of controlling and ensuring the correct assessment of the incoming loads as follows: -

- (a) Must be able to read & write
- (b) Speak English, Afrikaans, Tsonga & N-Sotho
- (2) The Contractor must allow for a minimum of one security guard at a time, 24 x hours per day
- (3) Should the Contractor require further security measures to protect equipment and property he might take such measures at his own cost

viii) Major functions

- (1) Gate and access control
- (2) Maintenance of access within the site
- (3) Waste deposition
- (4) Handling and managing the recyclers and recyclables
- (5) The Contractor must ensure to remove immediately all FULL containers & are not allowed to keep overflowing containers for longer than 6 x hours
- (6) The Contractor shall ensure that carcasses disposed of at the Tzaneen Landfill Site on a daily basis

ix) Waste deposition

- (1) The site may only be utilized as a D.o.C.
- (2) No landfill activities shall be allowed on the site

x) Access Road @ urban D.o.C.s

- (1) The Contractor shall maintain gravel access roads to the depositing area as and when necessary during the Contract period
- (2) The roads must be: -
 - (a) Usable in both wet and dry conditions & able to accommodate two large passing vehicles comfortably.
 - (b) Sufficiently smooth and even to enable large loaded vehicles to travel at 20 x km/h without damage or discomfort
 - (c) Flat enough to enable vehicles to stop and move off without undue difficulty and slipping
- (3) The Contractor shall be responsible for the maintenance of all temporary and permanent access roads, which work will include: -
 - (a) The watering of the surface to prevent dust nuisance
 - (b) The grading and filling in of pot-holes from time to time
 - (c) The resurfacing of the road with selected graded material and any other repair work to ensure that access to the working area is provided in a safe and usable condition, to the satisfaction of the Manager: Solid Waste Management.

xi) Traffic control and direction signs

- (1) Clear and easily understandable traffic control and direction signs must be provided from the site entrance to the off-loading point at the working place
- (2) Space must be available at the working face to enable vehicles to maneuver and reverse without causing excessive congestion
- (3) In order to avoid overturning of vehicles, the working face area must also be located and graded so that the vehicles operate on level ground.

xii) Nuisance control

- (1) The Contractor shall take all reasonable measures to operate the site so as to reduce and, where possible, prevent nuisance such as: -
 - (a) Odors (by applying sanitary procedures)
 - (b) Dust (by means of watering)
 - (c) Flies and rodents (by applying sanitary & pest-control procedures)
 - (d) Noise by ensuring that all plant silencers, etc. are in good working order.
 - (e) Windblown litter (by applying sanitary procedures)

xiii) Wet weather

- (1) Vehicles may become stuck in the mud when the site is wet, & the Contractor shall have available on site at all times heavy-duty towropes or tow bars, and he shall assist any vehicle, which becomes stuck on the site with minimal delay.
- (2) Stuck vehicles must be towed out and under no circumstances may they be pushed out
- (3) The Contractor will be held responsible for the cost or repairs to any vehicle, which has been damaged due to being pushed instead of towed.
- (4) The contractor shall ensure that even during wet weather, kerbside removals are done on the scheduled days and times. Exceptions will be made in the event of or occurrence of floods.

xiv) Record keeping

- (1) The Contractor shall maintain detailed daily records of the following and these shall be available for inspection at all times: -
 - (2) Record keeping book
 - (a) Indicating the number of loads (including the registration and size of each vehicle)
 - (b) Daily quantities of waste handled (in terms of volumes)
 - (3) Site diary as follows: -
 - (a) Complaints
 - (b) Accidents
 - (c) Breakdowns and stoppages
 - (d) Rainfall
 - (e) Hazardous material turned away.

(f) Site instruction book

xv) Entrance control register

- (1) Recording of all entry details as per attached entrance register or other document / apparatus approved by the H.o.D. Tzaneen Solid Waste
- (2) The abovementioned will be compiled in a report and submitted to the client not later than the tenth of the following month
- (3) Failure to comply with this date of submission will result in penalties being imposed.

xvi) Scattered waste

- (1) The keeping of the site and its surrounds neat and clean by the removal of all windblown or scattered refuse and the picking up of all litter emanating from the operation. This must be performed daily.

xvii) Buildings

- (1) The Contractor will supply his own Municipal approved temporary buildings and be responsible for the care and maintenance of all buildings and structures on the site
- (2) Maintenance shall include the periodic repairing of and, if necessary, the making good of any damage.

xviii) Berms and storm water drainage

- (1) The Contractor shall be responsible for provisioning & keeping of berms and storm water channels so that it will perform their intended function.

xix) Fences, gates and access control

- (1) The Contractor shall keep the fences and gates (once they have been installed) of both the perimeter and Contractor's enclosure in good order and shall repair any damage cause to them

xx) Council's Equipment

- (1) The Contractor will be responsible for the security of all Council equipment stored on the site.

xxi) Screening Vegetation

- (1) The visual impact of the site is to be improved by the establishment of screening vegetation as follows: -
 - (2) Maintain the trees already planted
 - (3) Plant 2 x staggered rows of trees
 - (4) Fertilize & water the trees on site

xxii) Notice board & signposting

- (1) The contractor shall supply and erect, at an approved location, one weatherproof notice board & signposts in accordance with the current guidelines of the DWAF, and to the Manager, Tzaneen Solid Waste's approval

xxiii) Skip-container provision

- (1) 1 x Skip for organic waste

- (2) 1 x Skip for recycled waste
- (3) 1 x Skip for general waste
- (4) 1 x Skip for standby purposes
- (5) 2 x additional skips

r) Operations @ Rural D.o.C.s

i) All Rural D.o.C.s must be provided with a **MINIMUM** of 4 x 6m³ Skip-containers (ON-CALL as required by the Manager Solid Waste Management) to accommodate all incoming waste as follows: -

- (1) 1 x Skip for recycled papers
- (2) 1 x Skip for recycled tins
- (3) 1 x Skip for recycled plastic
- (4) 1 x Skip for general waste

ii) The Contractor must ensure to remove all FULL containers as prescribed & are not allowed to keep overflowing containers for longer than 6 x hours

3) Action plan

- a) The Contractor shall execute the specifications to carry out the operation
- b) In addition, the Contractor shall also comply with minimum requirements of the plant and personnel complement to carry out the plan
- c) Whenever required by the Manager, Waste Management, the Contractor shall furnish in writing such additional particulars concerning the operation, plant, personnel, etc., as he may require
- d) Neither the Manager, Waste Management nor a delegated official shall relieve the Contractor of any of his duties or responsibilities under the Contract.

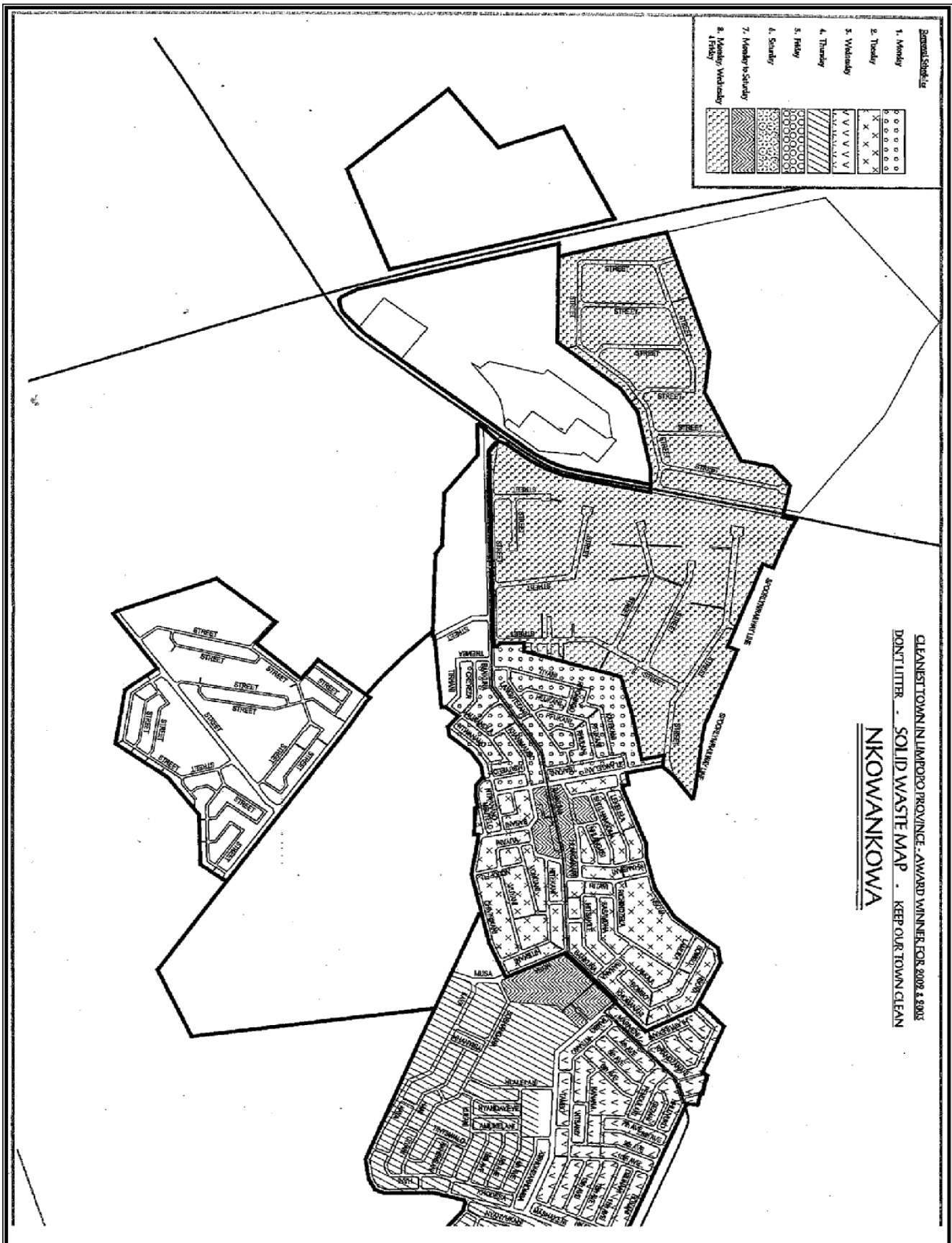

Annexure 1 (Nkowankowa No.1)

Annexure 2 (Nkowankowa No. 2)

CLEANEST TOWN IN LIMPOPO PROVINCE - AWARD WINNER FOR 2002 & 2003
 ONE T LITTER - SOLID WASTE MAP - KEEP OUR TOWN CLEAN

NKOWANKOWA

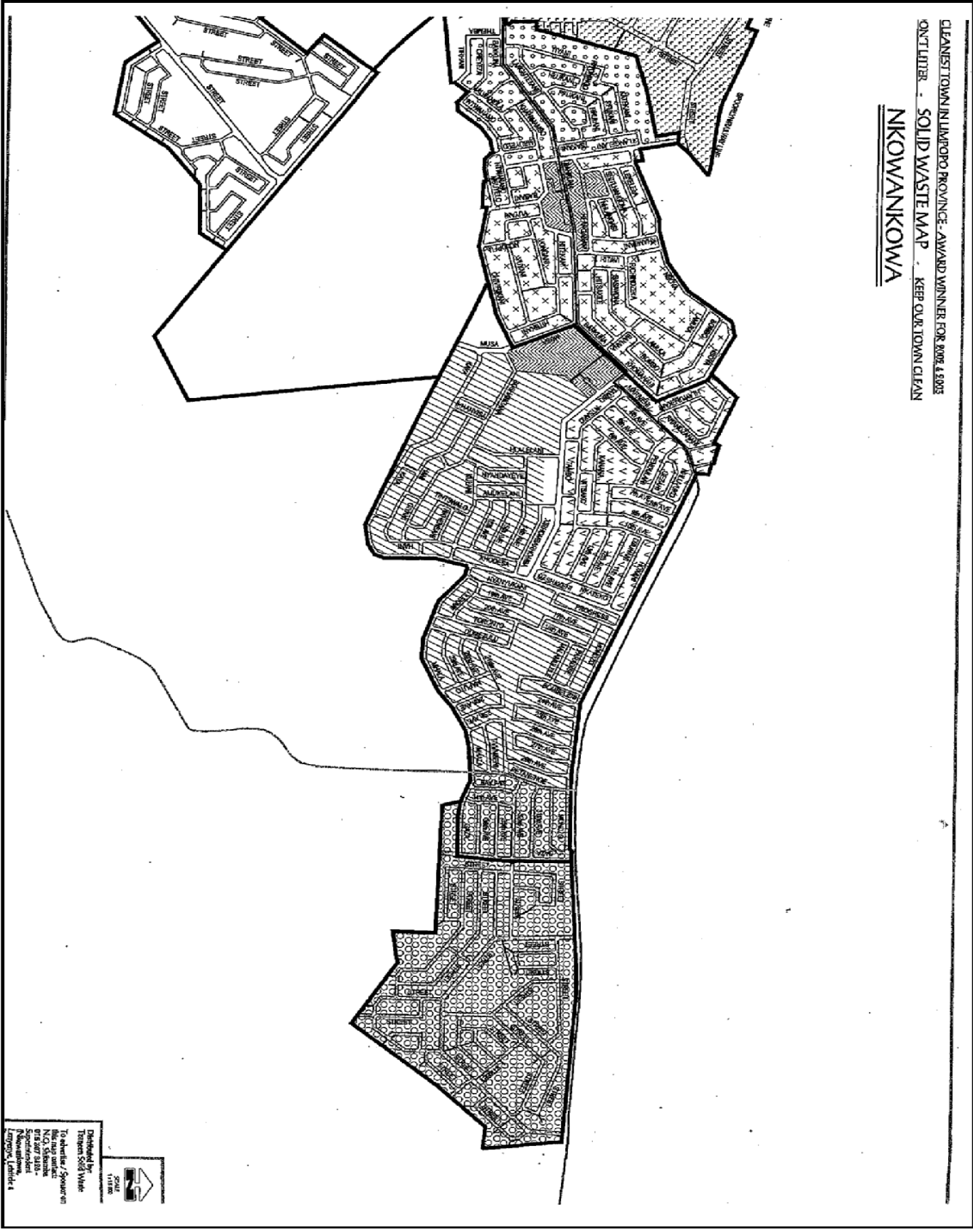

Distributed by
 TOWN & COUNCIL
 Nkowankowa
 The map was made by
 N.C.S. Sibanda
 015 207 0100
 Nkowankowa
 Limpopo, South Africa

Annexure 3 (Dan Extensions-on Mondays)

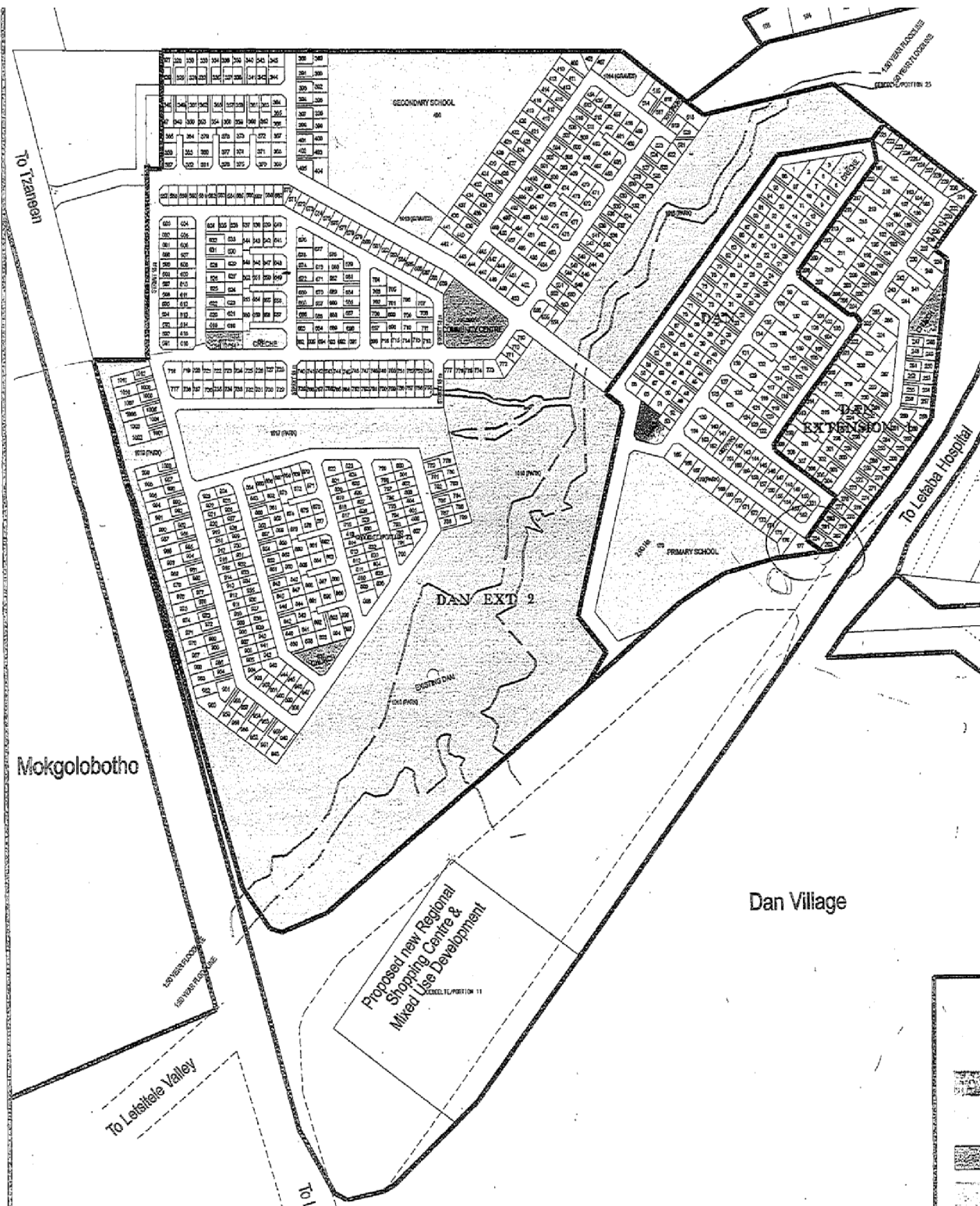

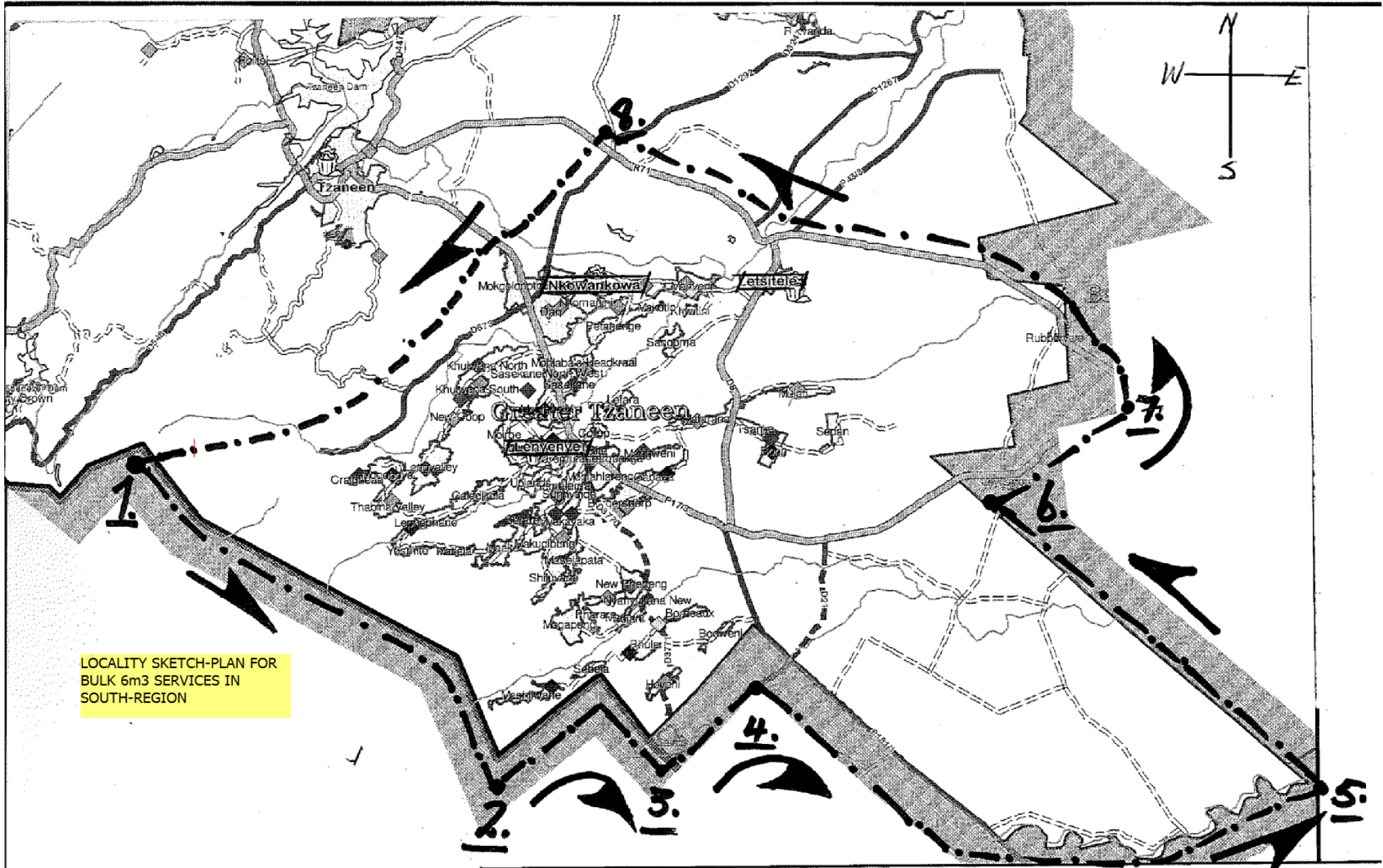

LOCALITY SKETCH-PLAN FOR BULK 6m3 SERVICES IN SOUTH-REGION

Annexure 5 (Premises with an immediate need of bulk services)

<u>Bulk Schedules -Summary</u>									-
<u>No</u>	<u>Name Of Premises</u>	<u>No</u>	<u>M/Day</u>	<u>T/Day</u>	<u>W/Day</u>	<u>T/Day</u>	<u>F/Day</u>	<u>S/Day</u>	<u>Lifts</u>
1	Alles Boerdery pack house- Letsitele	1			1				1
3	Bindzulani Centre	1					1		1
4	Bona Liquor Pub	1				1			1
5	Bush Valley Chickens (Nkw) Supermarket	1	1		1		1		3
6	Bush Valley Chickens Rainbow store room	1	1		1		1		3
7	Casa Roof Tiles	1					1		1
9	Cheers Supermarket	1	1						1
11	C.N. Phatudi Hospital	1	1						1
12	Du Roi Nursery	1		1					1
13	Du Roi Lab	2				2			2
14	Granor Passi	4				4			4
20	Houers Koop	3	3		3		3		9
22	L.C.P.	1			1				1

24	Letaba Disabled School	1			1				1
25	Letaba Estates	6	6				6	-	12
26	Letaba Hospital	4	4		-	4	-		8
27	Letsitele Koop	3			3				3
29	Letsitele Build It	1					1		1
30	Limpopo Economic Development Enterprise (Nkow)	1			1				1
31	Limpopo Economic Development Enterprise (Len)	1	1						1
33	Maake FET	1	1						1
34	Maake Plaza	6	6					6	12
35	Maake Police Station	1		1					1
41	Nkowankowa Stadium	2	2	-	-	-	2		4
42	Peppa Dew	3	3	3	3	3	3	3	18
44	Phakathi Milling	1		1					1
46	S.A.Home	1	1			1			2
48	CN Phatudi hospital	2	2				2		4

49	Shiluvane Hospital	1	1				1		2
50	Tivumbeni College								
51	Nkowankowa Drop-Of-Centre	12	12		12		12		36
52	Letsitele Drop-Of-Centre	4	4		4		4		12
53	Lenyenye Drop-Of-Centre	4	4		4		4		12
54	On-Call supply of skips / month when requested	10	ON-CALL						
55	Total Number of skips for initial implementation	80	57	20	48	19	55	21	149
56	Rural Drop-Of-Centres (On-Call 10 x skips / month)	66	11	11	11	11	11	11	66

4) SPECIFICATIONS FOR THE MANUFACTURING & PLACEMENT OF WASTE-UTENSILS

a) Detail of Service Area

- i) The Tenderer must obtain a map of Tzaneen (scale 1:5000) from the Building Section of Greater Tzaneen Municipality at own cost for the purpose of the tender
- ii) The required utensils will be placed at various positions throughout the area of jurisdiction of Greater Tzaneen Municipality

b) Specifications (Attached hereby are photos & basic specifications)

i) Concrete Roadside Refuse-Bin (Design)

(1) Basic specifications viz: -

(a) Height = 0,900 m

(b) Width = 610 mm

- (c) Outside cover small marbles/pebbles fixed in concrete
- (d) Solid concrete footing



ii) Pendula Swing-Bins (Design)

(1) Basic specifications viz: -

- (a) Frame from 100-125 c.c.a.-treated timber
- (b) Swing bracket secured to poles & drum with 4 cm bolts
- (c) Drum to be re-enforced with 3mm steel plates inside & outside at point of securing it to 4cm bolts
- (d) Bolts to be spot-welded to nuts to ensure durability
- (e) Overhead re-enforced pole as per photo properly secured to upright poles
- (f) N.B. See attached photos for other specifications
- (g) 20 mm holes in the bottom of drum to allow for water-drainage
- (h) Pendula wording on 1 x side “Don’t litter”
- (i) Pendula wording on 1 x side “Keep our town clean”
- (j) Drum colour outside = “Brilliant Orange”
- (k) Drum colour inside = “Red Oxide”
- (l) Letter size = 7cm`s in “pitch-black paint
- (m) Basic wording (wording lay-out)



- (n) These undermentioned photos only indicate the “*Wording*” & not the design



iii) Wheelie-Bin Design (Design)

(1) Basic specifications

- (a) Colour = Brilliant Orange
- (b) Number on trolleys as required with official order embossed in “pitch-black”
- (c) Volume = 210 liter



iv) No Dumping Signposts (Design)

(1) Basic Specifications

- (a) Brilliant orange background (S.A.B.S. ROOF PAINT-submit S.A.B.S. certification)
- (b) Pitch-black letters (S.A.B.S. OUTDOOR PAINT-submit S.A.B.S. certification)
- (c) Board size = 540mm x 390mm
- (d) Letter size = to fill the board completely as per sample specifications
- (e) Sample design must be submitted to match this specification
- (f) Erect on a wooden-pole= 3m x 76mm to be secured with a concrete footing



v) Rocla Re-Inforced Concrete Pipes // Roadside Dustbins (Design)

(1) Basic Specifications

(a) Re-inforced round concrete pipes (SANS 676 & 677) manufactured by Rocla to be erected for use along major motorways and in picnic areas, as per instruction of Greater Tzaneen Municipality, to effectively replacing the traditional metal-dustbin

(b) Size

(i) 0.610 m in diameter

(ii) 1,320 m in length

(c) Painting requirements viz: -

(i) Background painted according to industry standards (S.A.B.S. certification) with brilliant-orange roof paint supplied by PROMINENT PAINTS

(ii) Words painted according to industry standards (S.A.B.S. certification) with pitch-black outdoor paint supplied by PROMINENT PAINTS

Wording on 1st side = **TZANEEN SOLID WASTE**

DON'T LITTER

Wording on 2nd side = **TZANEEN SOLID WASTE**

KEEP OUR TOWN CLEAN

(d) Letter size = 7 x cm`s & "mutatis mutandis" as per example of Pendula-bins

(e) Erection requirements

(i) Pipes must expose above N.G.L.= 0.900 x m

(ii) Pipes inserted below N.G.L.= 0.320 x m

(iii) Inside & outside filling with natural soil up to N.G.L. and well compacted

(iv) Level = vertical straight-up (plumb)

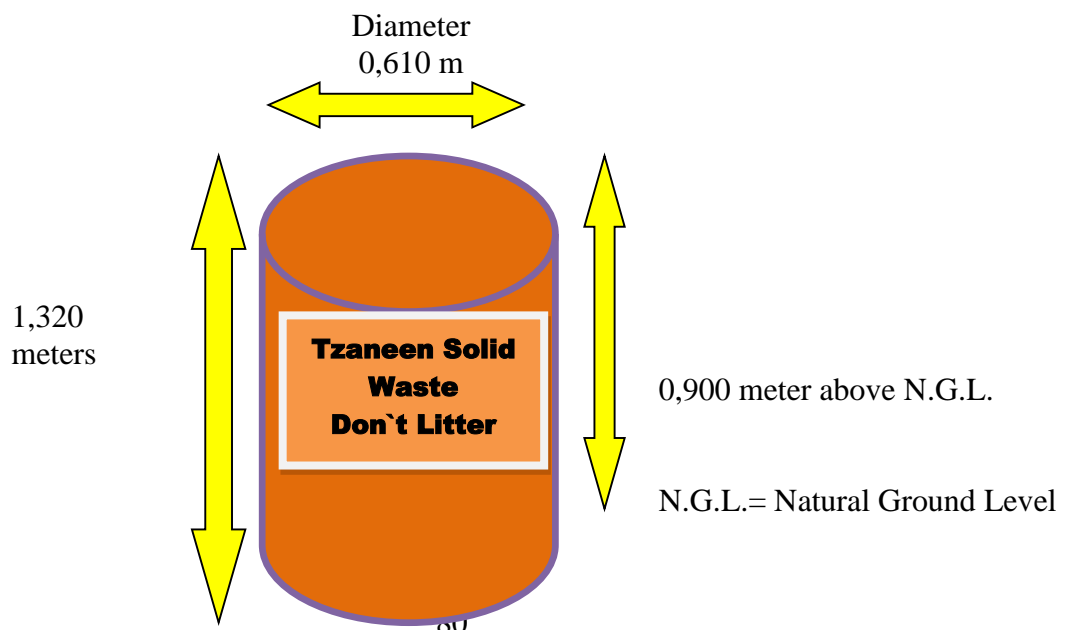



0,320 meter below N.G.L.

- a) It will be required from the successful Tenderer to manufacture & place waste-utensils at pre-arranged positions within 30 x days after such official order and/or instruction was issued to the Tenderer

4) ACTION PLAN

- a) The prospective Contractor shall as part of the Tender, comply at all times with the programs and methods as prescribed to carry out the operation
- b) In addition to the Action Plan, the prospective Contractor provide the plant and personnel complement required to carry out his task/s
- c) Whenever required by the Manager: Solid Waste Management, the successful Contractor shall furnish in writing such additional particulars concerning the operation, plant, personnel, etc., as he may require
- d) Approval by the Manager: Solid Waste Management // Delegate of such action plan, or the furnishing of the additional particulars, shall not relieve the Contractor of any of his duties or responsibilities under the Contract.
- e) The Contractor shall at all times comply with the requirements of all Service Level Specifications and shall not deviate from it
- f) This Service Level Specifications is the only legal condition governing the operations as such a no relaxation by any Official / Councilor shall be binding on the performance

5) SCHEDULE OF MINIMUM PLANT TO BE DEPLOYED (READ WITH THE ORGANIZATIONAL-LAYOUT PLAN)

- a) The Tenderer must deploy minimum required plant viz: -

- i) Nkowankowa Kerbside collections

Required plant

- (1) 1 x 21 m³ R.E.L. (Rear End Loader Compactor Truck) with: -

- (a) A top winch

- (b) Fluorescent tube-holder as follows: -

- (i) Appropriate length to store and transport all collected tubes during operations

- (ii) Fitted at an incline on the removal vehicle

- (iii) 2 x screw-thread lids at the top and bottom-ends to secure safe-transportation

- ii) Non capital tools and equipment egg. viz: -

- (a) Spades
- (b) Fork/s
- (c) Bag/s
- (d) Broom/s
- (e) Rake/s

iii) Bulk-removal infrastructure

(1) 1 x 21 m³ R.E.L. with: -

- (a) A top winch
- (b) Fluorescent tube-holder as follows: -
 - (i) Appropriate length to store and transport all collected tubes during operations
 - (ii) Fitted at an incline on the removal vehicle
 - (iii) 2 x screw-thread lids at the top and bottom-ends to secure safe-transportation

(2) 2 x Skip-loaders

(3) 130 x 6m³ Skips must be immediately available

(4) Additional supply of 10 x 6m³ Skips within 30 x days when needed

iv) Illegal dumping removals

(1) 1x front end loader (TLB)

(2) 2x Tipper trucks

v) Monitoring of Bulamahlo and Lesedi Cluster for effective removals

(1) 3x light delivery vehicles (for monitoring and during wet weather be deployed to do removals).

vi) Applicable P.P.E. s

vii) Ensure high pressure cleaning // washing of vehicles at an approved wash-bay // area

6) SCHEDULE OF MINIMUM STAFF & WORKMEN

a) The Tenderer must employ the following staff & workmen as detailed in the space below & must be red with the organizational layout as required

b) Table staff requirements

<u>CATEGORY</u>	<u>NUMBER</u>	<u>MEMBER OF</u> <u>I.W.M.</u>

Operational Manager	01	Required
Snr. Team leaders	03	Not-required
Snr. Labourers	11	Not-required

c) Labour returns

i) It is required that the Contractor shall submit labour returns by means of "Timesheets" & "Salary-rates being paid" for the following staff as follows viz: -

- (1) Operational Manager
- (2) Admin Officer
- (3) Snr. Team leaders
- (4) Snr. Labourers

Complete timesheets shall serve as Proof of Evidence for monthly payments and must be attached to the Tax-Invoice for submission showing

ii) Stand Number: -

Name of premises: -

C. BILL OF QUANTITIES & PRICING INSTRUCTIONS

1) GENERAL

- a) The pricing instructions describe the criteria and assumptions which will be assumed in the Contract that the Bidder has taken into account when developing his prices
- b) The Bills of Quantities record the Contractor's rates for providing supplies, services, removals, transportation, storage, disposal + treatment, engineering, construction and other works in accordance with the Scope of Work
- c) The terms of payment are established in the contract data
- d) The Bidder's obligations in pricing the bid-offer and the Employer's undertakings in the checking and correction of arithmetical errors is confirmed here-with.

2) DOCUMENTS MUTUALLY EXPLANATORY

- a) The documents forming the Contract are to be taken as mutually explanatory of one another
- b) The Bill of Quantities forms an integral part of the Contract Documents and shall be read in conjunction with all Conditions of the contract.

3) DEFINITIONS

- a) For the purpose of this Bill of Quantities, the following words shall have the meanings hereby assigned to them: -
 - i) Unit = The unit of measurement for each item of work as defined in the Contract specifications
 - ii) Quantity = The number of units of work for each item
 - iii) Rate / Price = The payment per unit of measurement
 - iv) Amount = The rate bid for total number of units
 - v) Contract Price = Total amount for the contracted section of the tender requirements

4) DESCRIPTIONS

- a) Descriptions in the B.o.Q are abbreviated and comply generally with those in the specifications
- b) Specification read together with the relevant clauses of the Scope of Work, set out what ancillary or associated activities are included in the rates for the operations specified
- c) Should any requirements of the measurement and payment clause of the applicable specification, or the Scope of Work, conflict with the terms of the B.o.Q. the requirements of the specification or Scope of Work shall prevail.

5) REFERENCES

- a) The clauses in a specification in which further information regarding the schedule item can be obtained appear under "Reference clause" in the B.o.Q.
- b) The reference clauses indicated are not necessarily the only sources of information in respect of scheduled items
- c) Further information and specifications may be found elsewhere in the contract documents

6) UNITS OF MEASUREMENT

- a) The units of measurement indicated in the B.o.Q. is metric units
- b) The following generic abbreviations will be applicable & utilized in the B.o.Q: -
 - i) % = per cent
 - ii) h = hour
 - iii) ha = hectare
 - iv) kg = kilogram
 - v) k l= kilolitre
 - vi) km = kilometer
 - vii)km-pass = kilometer-pass
 - viii) Kw = kilowatt
 - ix) l = litre
 - x) m = meter
 - xi) Mm = millimetre
 - xii)MN = mega Newton
 - xiii) MN-m = meganewton-metre
 - xiv) MPa = mega Pascal
 - xv) m² = square meter
 - xvi) m³ = cubic meter
 - xvii) m³-km = cubic meter-kilometer
 - xviii) m²-pass = square meter-pass
 - xix) no = number
 - xx) PC sum = Prime Cost sum
 - xxi) Prov Sum = Provisional Sum
 - xxii) sum = lump sum
 - xxiii) t = ton (1 000 kg)

7) NET MEASUREMENTS

- a) Unless otherwise stated, items will be measured in accordance with the specification; descriptions, and no allowance is made for off-cuts and waste

8) QUANTITIES

- a) The quantities set out in the Bill of Quantities are the estimated quantities of the Contract Works
- b) The Contractor will be required to undertake whatever quantities may be directed by the Divisional Head of Tzaneen Solid Waste from time to time

9) CURRENCY

- a) All rates and sums of money quoted in the Bill of Quantities shall be in Rand and whole cents.

b) Fractions of a cent shall be discounted.

10) VALUE ADDED TAX

a) V.A.T. shall be inclusive in submission of the of rates and sums contracted for the various line items of work in the Bill of Quantities

11) RATES AND PRICES

a) General

i) The Contractor must price each item in the Bill of Quantities in *BLACK INK*

ii) *REPRODUCED COMPUTER PRINTOUTS* of the Bills of Quantities will not be acceptable

iii) The rates and prices to be inserted in the Bill of Quantities shall cover all the services and incidentals for the work described under the several items.

iv) Such prices and rates shall cover all costs and expenses that may be required in and for the execution of the work described, and shall cover the cost of all general risks, liabilities and obligations set forth or implied in the documents on which the bid is based, as well as overhead charges and profit.

v) Reasonable prices shall be inserted as these will be used as a basis for assessment of payment for additional work that may have to be carried out.

vi) Where the Contractor is required to furnish detailed drawings and designs or other information in terms of the Contract Data, all costs thereof shall be deemed to have been provided for and included in the unit rates and sum amounts contracted for the items scheduled in the Bill of Quantities

(1) Separate additional payments will not be made.

vii) A price or rate is to be entered against each item in the Bill of Quantities, whether the quantities are stated or not.

viii) An item against which no price is entered will be considered to be covered by the other prices or rates in the Bill.

ix) The Contractor will not be paid for items against which no rate or lump sum has been entered in the Bill of Quantities.

x) Should the Contractor group a number of items and contract one lump sum for such group of items, this single lump sum shall apply to that group of items and not to each individual item.

xi) Should the Contractor indicate against any item that compensation for such item is included in another item; the rate for the item included in another item shall be deemed nil.

xii) A submission may be regarded as non-responsive if any rates or lump sums in the Bill of Quantities are, in the opinion of the Employer, unreasonable or out of proportion.

b) Rates only-items

- i) The Contractor shall fill in a rate (in the rate column) against all items where ONLY the "rate" is required, which rate will constitute payment for work which may be done in terms of this item
 - ii) Such "rate" items are used where it is estimated that work will be required where the quantity is substantiated by additional information regarding hours, volumes etc. to determine a line-item costing
- c) Arithmetic
- i) The Contractor shall enter an applicable rate / price in the appropriate-column of the Bill of Quantities for each scheduled item.
 - ii) The Contractor shall calculate the total amount for each "group-of-items" in the Bill of Quantities
 - iii) He shall also enter an appropriate sum in the total amount-column for each scheduled item, by determining in the applicable line item the product of the quantity and the unit rate.
 - iv) If there is an error in the line item resulting from the calculations it will be corrected by the Employer in determining the price.
 - v) Where there is an error in addition, either as a result of corrections required by this checking process or in the Bidder's addition of prices, such error will be corrected by the Employer in determining the price

12) VARIATION IN TEXT

- a) No alteration, erasure or addition is to be made in the text and/or the Bill of Quantities.
- b) Should any alteration, erasure or addition be made, it will not be recognized.
- c) The original wording of the Bill of Quantities will be adhered to

13) ESCALATIONS

- a) The annual price increase will be calculated in accordance with the following viz: -
 - i) Annual C.P.I.X. for the Republic of South Africa for the specific Sector
 - ii) The Contractor will be expected to submit annually Proof of Evidence for the increase as certified and calculated by FINANCIAL ACCOUNTANT (C.F.A.)

14) BILL OF QUANTITIES

- a) Having examined the general specifications, plans for the operation and maintenance of the abovementioned works
- b) I / We offer to operate and maintain the whole of the said works in conformity with the general conditions and plans as amended by the "Alterations by Tenderer" (if any) attached hereto
- c) In the event of there being any errors of extension or addition in the price, I / We agree to being corrected, the corrected rates being taken as correct
- d) I / We undertake to operate and maintain the whole of the works comprised in the Tender for the duration stated in the Tender

- e) If my / our tender is accepted, I / we will, when required and within the time stipulated, provide a cash deposit or the guarantee of a Bank or Insurance Company (to be approved by you) to be jointly and severally bound with me / us in a sum not exceeding the value of 10% of the work of the above named sum, for the due performance of the Tender
- a) Unless and until a formal agreement is prepared and executed, this tender, together with the written acceptance thereof by you, shall constitute a binding Contract between us
- f) I / We understand that you are not bound to accept the lowest or any tender you may receive
- g) I / we tender as follows & in accordance with the B.o.Q viz: -

<u>BILL OF QUANTITIES</u>						
A. <u>SALARIES, BONUSES & OTHER STATUTORY CONTRIBUTIONS</u>						
1.	Description / Units	Quantity	Price / Rate	Total monthly	Total 1 x year	Total 3 x years
2.	Ops. + Admin. Manager	1				
3.	Snr. T/Leader	3				
4.	Labourers	11				
5.	Total Section A	xxx	xxx	R	R	R
B. <u>PERFORMANCE BONUS</u>						
6.	Description / Units	Quantity	Price / Rate	Total monthly	Total 1 x year	Total 3 x years
7.	Ops. + Admin. Manager	1				
8.	Snr. T/Leader	3				
9.	Labourers	16				
10.	Total Section B	xxx	xxx	R	R	R
C. <u>OVERTIME</u>						
11.	Description / Units	Quantity	Price / Rate	Total monthly	Total 1 x year	Total 3 x years
12.	Ops. + Admin. Manager	1				

13.	Snr. T/leader	3				
14.	Labourer	11				
15.	Total Section C	xxx	xxx	R	R	R
D. <u>REPAIRS & MAINTENANCE</u>						
16.	Description / Units	Quantity	Price / Rate	Total monthly	Total 1 x year	Total 3 x years
17.	6m ³ Skips	4				
18.	Vehicles + Infrastructure	3				
19.	Office machinery + furniture	1				
20.	Total Section D	xxx	xxx	R	R	R
A. <u>TRAVELLING EXPENSES (NB: All REL's and Skip trucks to be new or in good working condition)</u>						
21.	Description / Units	Quantity	Price / Rate	Total monthly	Total 1 x year	Total 3 x years
22.	1x 21m ³ R.E.L.	2				
23.	Skip loader	2				
24.	3 x L.D.V.	3				
25.	Total Section E	xxx	xxx	R	R	R
B. <u>NON-CAPITAL TOOLS & EQUIPMENT</u>						
26.	Description / Units	Quantity	Price / Rate	Total monthly	Total 1 x year	Total 3 x years
27.	Trolleys	10		xxxx	xxxx	
28.	Brooms	10		xxxx		
29.	Prickers	10		xxxx	xxxx	
30.	Scoops	10		xxxx		
31.	85 x lit. Polypropylene-Bags	1000		xxxx		
32.	Cell phones	3		xxxx	xxxx	
33.	Spades	10		xxxx	xxxx	

34.	Lockers	12		xxxx		
35.	5 x lit. Cleansing-soap (liter)	30		xxxx		
36.	Body Soap (bar)	12		xxxx		
37.	Road Safety Cones	12		xxxx	xxxx	
38.	Total Section F	xxx	xxx	R	R	R

C. PERSONAL PROTECTIVE EQUIPMENT

39.	Description / Units	Quantity	Price / Rate	Total monthly	Total 1 x year	Total 3 x years
40.	Overalls	32		xxxx		
41.	Safety shoes	32		xxxx		
42.	Raincoats	32		xxxx		
43.	Hand gloves	32		xxxx		
44.	High visibility vests	32		xxxx		
45.	Socks	32		xxxx		
46.	Hats	32		xxxx		
47.	Pants	13		xxxx		
48.	Shirts	13		xxxx		
49.	Shoes	13		xxxx		
50.	Rain coat	13		xxxx		
51.	Jackets	13		xxxx		
52.	Belts	13		xxxx		
53.	Socks	13		xxxx		
54.	Towels	16		xxxx		
55.	Total Section G	xxx	xxx	R	R	R

D. GENERAL ITEMS

56.	Description / Units	Quantity	Price / Rate	Total monthly	Total 1 x year	Total 3 x years
57.	Redemption of loan (Vehicles; Skips + Infrastructure)	1				
58.	Advertising	1				
59.	Conference costs	1				
60.	Consumable domestic items	1				
61.	Insurance	1				
62.	Lease I.T. equipment	1				
63.	Licenses & permits - non-vehicles	1				
64.	Membership fees	1				
65.	Postage & courier fees	1				
66.	Printing & stationery	1				
67.	Public drivers permit	1				
68.	Contingencies (miscellaneous)	1				
69.	Subscriptions	2				
70.	Telephone	4				
71.	Admin // auditors costs	1				
72.	Municipal account	1				
73.	Vehicles Licenses	4				
74.	Supply & placement of a Roadside-dustbin	1		xxxxx	xxxxx	xxxxx
75.	Supply & placement of a No-dumping sign	1		xxxxx	xxxxx	xxxxx
76.	Supply & placement of a Wheely-bin	1		xxxxx	xxxxx	xxxxx
77.	Supply & placement of a Pendula -dustbin	1		xxxxx	xxxxx	xxxxx
78.	Removal of non-compactable waste in a G.T.M. 6m ³ Skip	1		xxxxx	xxxxx	xxxxx

79.	Removal of compactable waste in a G.T.M. 6m ³ Skip	1		xxxxxx	xxxxxx	xxxxxx
80.	Removal of non-compactable waste in a own 6m ³ Skip	1		xxxxxx	xxxxxx	xxxxxx
81.	Removal of compactable waste in a own 6m ³ Skip	1		xxxxxx	xxxxxx	xxxxxx
82.	Renting of a 6m ³ Skip per week to G.T.M.	1		xxxxxx	xxxxxx	xxxxxx
83.	Removal of a unit of (G) Waste	85 liter		xxxxxx	xxxxxx	xxxxxx
84.	Total Section H	xxx	xxx	R	R	R
85.	Grand Total Sections A-H (V.A.T. Inclusive)	xxx	xxx	R	R	R

E. KEY PERFORMANCE CRITERIA FOR FUNCTIONALITY

1) AUTHORITY TO SIGN DOCUMENTS

a) Mr./Me _____

is / are duly authorized to sign any form on behalf of the Tenderer by virtue of the following resolution viz:- (attach a certified abstract of the resolution)

SIGNATURE _____

CAPACITY _____

2) CONFIRMATION OF VISIT TO THE SITE BY THE TENDERER

a) This is to certify that I/We _____
representative/s of _____

studied the tender/contract documents thoroughly examined the site and are familiar with all local conditions likely to influence the work and the cost thereof. It further certifies that the Tenderer is satisfied with the description of the work and perfectly understand the work to be done in the execution of this Contract

SIGNATURE _____

CAPACITY _____

3) MEMBERSHIP

- a) Membership of the I.W.M.S.A. (Institute of Waste Management of South Africa.) is compulsory
- b) Membership-certificate must be attached as proof of evidence

SIGNATURE _____

CAPACITY _____

4) EXPERIENCE

- a) Minimum 5 x years' relevant experience in refuse removal operations or similar "Waste-Management" operations is required.
- b) Schedule of work satisfactorily carried out and currently done by the Tenderer (List contracts of the same nature and extents successfully completed)
- c) Insert as Proof of Evidence original or certified copies of Service-Certificates of each contract successfully completed

Employer	Consultant	Nature and Location of Work	Proof of Evidence (P.o.E.) attached

Signature_____

Capacity_____

5) QUALIFICATIONS

- i) The project Manager and assistant manager must have qualifications in Occupational Health and Safety.

SIGNATURE_____

CAPACITY_____

FUNCTIONALITY: Collection and transportation of (G) Waste in Nkowankowa and Bulk Waste Removal in Region South

Company Experience	Scoring	Weighting (AXB)/A
Three appointment letters	5	30
Two appointment letters	2	
One appointment letter	0	
Key Personnel	Scoring	Weighting
Operational Manager		20
(Submit CV and certified copies of certificates) 3 years relevant experience		
Qualification in Safety Management National Diploma in safety management plus registration with SAIOSH or SACPCMP	5	
Certificate in SAMTRAC plus registration with SAIOSH or SACPCMP	2	
No formal educational qualification	0	50
Plant and Equipment:	5	
2X 21 R.E.L Compactor Trucks		
2x skip loaders		
TLB (Back Actor)		
Tipper Truck		
3 x light delivery vehicles		
If all plant is not available	0	
Attach e-Natis as proof of ownership of plant; Attach a roadworthy certificate, not older than 6 months, as proof that the plant is in good working order.		

PART G

Collection and transportation of (G) Waste in Nkowankowa and Bulk Waste Removal in Region South for 3 years.

1. EXPERIENCE

Complete the below schedule regarding your company previous working experiences on this project.

Client	Contact Person	Contact Number	Contract Value	Contract Period

PART H

MBD 2

TAX CLEARANCE CERTIFICATE REQUIREMENTS

It is a condition of bid that the taxes of the successful bidder must be in order, or that satisfactory arrangements have been made with South African Revenue Service (SARS) to meet

THE BIDDER'S TAX OBLIGATIONS

- 1 In order to meet the requirements, bidders are required to complete in full the attached form TCC 00. "Application for a Tax Clearance Certificate" and submit it to any SARS branch office nationally. The Tax Clearance Certificate Requirements are also applicable to foreign bidders / individuals who wish to submit bids.
- 2 SARS will then furnish the bidder with a Tax Clearance Certificate that will be valid for a period of 1 (one) year from the date of approval.
- 3 The original Tax Clearance Certificate must be submitted together with the bid. Failure to submit the original and valid Tax Clearance Certificate will result in the invalidation of the bid. Certified copies of the Tax Clearance Certificate will not be acceptable.
- 4 In bids where Consortia / Joint Ventures / Sub-contractors are involved, each party must submit a separate Tax Clearance Certificate.
- 5 Copies of the TCC 001 "Application for a Tax Clearance Certificate" form is available from any SARS branch office nationally or on the website www.sars.gov.za.
- 6 Applications for the Tax Clearance Certificates may also be made via e-filing. In order to use this provision, taxpayers will need to register with SARS as e-filers through the website www.sars.gov.za.

PART I

MBD 4

DECLARATION OF INTEREST

- 1. No bid will be accepted from persons in the service of the state*.
- 2. Any person, having a kinship with persons in the service of the state, including a blood relationship, may make an offer or offers in terms of this invitation to bid. In view of possible allegations of favouritism, should the resulting bid, or part thereof, be awarded to persons connected with or related to persons in service of the state, it is required that the bidder or their authorised representative declare their position in relation to the evaluating/adjudicating authority and/or take an oath declaring his/her interest.

3. In order to give effect to the above, the following questionnaire must be completed and submitted with the bid.

- 3.1 Full Name:
- 3.2 Identity Number:
- 3.3 Company Registration Number:
- 3.4 Tax Reference Number:
- 3.5 VAT Registration Number:
- 3.6 Are you presently in the service of the state* (please circle the applicable one) *YES / NO
 - 3.6.1 If so, furnish particulars.
- 3.7 Have you been in the service of the state for the past twelve months? (please circle the applicable one) *YES / NO
 - 3.7.1 If so, furnish particulars.
.....
- 3.8 Do you, have any relationship (family, friend, other) with persons in the service of the state and who may be involved with the evaluation and or adjudication of this bid?
(please circle the applicable one) *YES / NO
 - 3.8.1 If so, furnish particulars.
.....

* MSCM Regulations: "in the service of the state" means to be –

- (a) a member of –
 - (i) any municipal council;
 - (ii) any provincial legislature; or
 - (iii) the national Assembly or the national Council of provinces;
- (b) a member of the board of directors of any municipal entity;
- (c) an official of any municipality or municipal entity;
- (d) an employee of any national or provincial department, national or provincial public entity or constitutional institution within the meaning of the Public Finance Management Act, 1999 (Act No.1 of 1999);
- (e) a member of the accounting authority of any national or provincial public entity; or
- (f) an employee of Parliament or a provincial legislature.

3.9 Have you been in the service of the state for the past twelve months?
(please circle the applicable one) *YES / NO

3.9.1. If yes, furnish particulars.....
.....

3.10. Are you, aware of any relationship (family, friend, other) between a bidder and any persons in the service of the state who may be involved with the evaluation and or adjudication of this bid? YES / NO

3.10.1. If so, furnish particulars
.....

3.11 Are any of the company's directors, managers, principal shareholders or stakeholders in service of the state? (please circle the applicable one) *YES / NO

3.11.1 If so, furnish particulars.
.....

3.12 Are any spouse, child or parent of the company's directors, managers, principal shareholders or stakeholders in service of the state? (please circle the applicable one) *YES / NO

3.12.1 If so, furnish particulars.
.....

4.Full details of directors / trustees / members / shareholders

Full Name	Identity Number	State Employee Number

Signature

Date

Capacity

Name of Bidder

CERTIFICATION

I, the undersigned (name).....

Certify that the information furnished on this declaration form is correct. I accept that the state may act against me should this declaration prove to be false.

.....
Signature

.....
Date

.....
Designation

.....
Name of Bidder

PART J

MBD 5

DECLARATION FOR PROCUREMENT ABOVE R10 MILLION (ALL APPLICABLE TAXES INCLUDED)

For all procurement expected to exceed R10 million (all applicable taxes included), bidders must complete the following questionnaire: Are you by law required to prepare annual financial statements for auditing? (Please circle applicable one) *YES/NO

1.1. If yes, submit audited annual financial statements for the past three years or since the date of establishment if established during the past three years.

.....

2. Do you have any outstanding undisputed commitments for municipal services towards any municipality for more than three months or any other service provider in respect of which payment is overdue for more than 30 days? (Please circle applicable one) *YES/NO

2.1. If no, this serves to certify that the bidder has no undisputed commitments for municipal services towards any municipality for more than three months or other service provider in respect of which payment is overdue for more than 30 days.

2.2 If yes, provide particulars.

.....
.....
.....

3. Has any contract been awarded to you by an organ of state during the past five years, including particulars of any material non-compliance or dispute concerning the execution of such contract? (Please circle applicable one) *YES/NO

3.1. If yes, furnish particulars

.....
.....

4. Will any portion of goods or services be sourced from outside the Republic of South Africa. If so, what portion and whether any portion of payment from the municipality / municipal entity is expected to be transferred out of the Republic? (Please circle applicable one) *YES / NO

4.1. If yes, furnish particulars

.....

PART K

MBD 6.1

PREFERENCE POINTS CLAIM FORM IN TERMS OF THE PREFERENTIAL PROCUREMENT REGULATIONS 2017

This preference form must form part of all bids invited. It contains general information and serves as a claim form for preference points for Broad-Based Black Economic Empowerment (B-BBEE) Status Level of Contribution

NB: before completing this form, bidders must study the general conditions, definitions and directives applicable in respect of B-BBEE, as prescribed in the preferential procurement regulations, 2017.

1. GENERAL CONDITIONS

1.1 The following preference point systems are applicable to all bids:

- The 80/20 system for requirements with a Rand value of up to R50 million (all applicable taxes included) and
- The 90/10 system for requirements with a Rand value above R50 million (all applicable taxes included).

1.2 (a) the value of this bid is estimated to exceed/not exceed R50 000 000 (all applicable taxes included) and therefore the preference point system shall be applicable; or

(b) Either the 80/20 or 90/10 preference point system will be applicable to this tender (delete whichever is not applicable for this tender).

1.3 Points for this bid shall be awarded for:

- (a) Price; and
- (b) B-BBEE Status Level of Contribution.

1.4. The maximum points for this bid are allocated as follows:

	POINTS
Price	80
B-BBEE status level of contributor	20
Total points for price and B-BBEE must not exceed	100

1.5 Failure on the part of a bidder to submit proof of B-BBEE status level of contributor together with the bid, will be interpreted to mean that preference points for B-BBEE status level of contribution are not claimed.

1.6. The purchaser reserves the right to require of a bidder, either before a bid is adjudicated or at any time subsequently, to substantiate any claim in regard to preferences, in any manner required by the purchaser.

2. DEFINITIONS

- (a) **“B-BBEE”** means broad-based black economic empowerment as defined in section 1 of the Broad-Based Black Economic Empowerment Act;
- (b) **“B-BBEE status level of contributor”** means the B-BBEE status received by a measured entity based on its overall performance using the relevant scorecard contained in the Codes of Good Practice on Black Economic Empowerment, issued in terms of section 9(1) of the Broad-Based Black Economic Empowerment Act;
- (c) **“bid”** means a written offer in a prescribed or stipulated form in response to an invitation by an organ of state for the provision of services, works or goods, through price quotations, advertised competitive bidding processes or proposals;
- (d) **“Broad-Based Black Economic Empowerment Act”** means the Broad-Based Black Economic Empowerment Act, 2003 (Act No. 53 of 2003);
- (e) **“EME”** means an excepted micro enterprise in terms of a quote of good practice on Black Economic Empowerment issued in terms of section 9(1) of the broad Based Economic Empowerment Act.
- (f) **“Functionality”** means the ability of a tenderer to provide goods or services in accordance with specifications as set out in the tender document.
- (g) **“Price”** includes all applicable taxes less on unconditional discounts.
- (h) **“Proof of BEE status level of contributor”** means
 - 1) BBBEE status level certificate issued by an authorized body or person
 - 2) Sworn Affidavit as prescribed by the BBBEE codes of codes practice.
 - 3) an other requirements prescribed in terms of the BBBEE Act.
- (I) **“QSE”** means a qualifying small business enterprise in terms of a code of good practice on Black Economic Empowerment issued in terms of section 9(1) of the Broad Black Economic Empowerment Act.
- (j) **“rand value”** means the total estimated value of a contract in rand, calculated at the time of bid invitations, and includes all applicable taxes and excise duties;

3. POINTS AWARDED FOR PRICE

3.1 THE 80/20 or 90/10 PREFERENCE POINT SYSTEMS

A maximum of 80 or 90 points is allocated for price on the following basis:

80/20

90/10

$$P_s = 80 \left(1 - \frac{P_t - P_{\min}}{P_{\min}} \right) \text{ Or } P_s = 90 \left(1 - \frac{P_t - P_{\min}}{P_{\min}} \right)$$

Where

- Ps = Points scored for comparative price of bid under consideration
 Pt = Comparative price of bid under consideration
 Pmin = Comparative price of lowest acceptable bid

5. POINTS AWARDED FOR B-BBEE STATUS LEVEL OF CONTRIBUTION

5.1 In terms of Regulation 6 (2) and 7 (2) of the Preferential Procurement Regulations, preference points must be awarded to a bidder for attaining the B-BBEE status level of contribution in accordance with the table below:

B-BBEE Status Level of Contributor	Number of points (90/10 system)	Number of points (80/20 system)
1	10	20
2	9	18
3	6	14
4	5	12
5	4	8
6	3	6
7	2	4
8	1	2
Non-compliant contributor	0	0

5. BID DECLARATION

5.1 Bidders who claim points in respect of B-BBEE Status Level of Contribution must complete the following:

6. B-BBEE STATUS LEVEL OF CONTRIBUTION CLAIMED IN TERMS OF PARAGRAPHS 1.4 AND 4.1

6.1 B-BBEE Status Level of Contribution: = (maximum of 20 or 10 points)

(Points claimed in respect of paragraph 7.1 must be in accordance with the table reflected in paragraph 4.1 and must be substantiated by relevant proof of B-BBEE status level contributor).

7. SUB-CONTRACTING

7.1 Will any portion of the contract be sub-contracted? (Tick applicable box)

YES		NO	
------------	--	-----------	--

7.1.1 If yes, indicate:

- (i) What percentage of the contract will be subcontracted?%
- (ii) The name of the sub-contractor?
- (iii) The B-BBEE status level of the sub-contractor?
- (iv) Whether the sub-contractor is an EME/SME? YES / NO

(Tick applicable box)

(V) Specific, by ticking the appropriate box, if subcontracting with an enterprise in terms of preferential Procurement Regulations, 2017:

Designated Group: An EME or QSE which is at last 51% owned by	EME	QSE
Black People		
Black People who are youth		
Black People who are woman		
Black People with disabilities		
Black People living in rural or underdeveloped areas or townships		
Cooperative owned by black people		
Black People		
Black People who are military veterans		
Or		
Any EME		
Any QSE		

8. DECLARATION WITH REGARD TO COMPANY/FIRM

8.1 Name of the business:

8.2 VAT registration number :

8.3 Company registration number.....

8.4 TYPE OF COMPANY/ FIRM [TICK APPLICABLE BOX]

- Partnership/Joint Venture / Consortium
- One-person business/sole proprietor
- Close corporation
- Company
- (Pty) Limited

8.5 DESCRIBE PRINCIPAL BUSINESS ACTIVITIES

.....
.....
.....
8.6 COMPANY CLASSIFICATION [TICK APPLICABLE BOX]

- Manufacturer
- Supplier
- Professional service provider
- Other service providers, e.g. transporter, etc.

[TICK APPLICABLE BOX]

8.7 MUNICIPAL INFORMATION

Municipality where business is situated
.....

Registered Account Number

Stand Number

8.8 Total numbers of years the company/firm has been in business?

8.9 I/we, the undersigned, who is / are duly authorised to do so on behalf of the company/firm, certify that the points claimed, based on the B-BBEE status level of contribution indicated in paragraph 1.4 and 6.1 of the foregoing certificate, qualifies the company/ firm for the preference(s) shown and I / we acknowledge that:

- (i) The information furnished is true and correct;
- (ii) The preference points claimed are in accordance with the General Conditions as indicated in paragraph 1 of this form.
- (iii) In the event of a contract being awarded as a result of points claimed as shown in paragraph 1.4 and 6.1, the contractor may be required to furnish documentary proof to the satisfaction of the purchaser that the claims are correct;
- (iv) If the B-BBEE status level of contribution has been claimed or obtained on a fraudulent basis or any of the conditions of contract have not been fulfilled, the purchaser may, in addition to any other remedy it may have –
 - (a) Disqualify the person from the bidding process;
 - (b) Recover costs, losses or damages it has incurred or suffered as a result of that person’s conduct;
 - (c) Cancel the contract and claim any damages which it has suffered as a result of having to make less favourable arrangements due to such cancellation;
 - (d) Restrict the bidder or contractor, its shareholders and directors, or only the shareholders and directors who acted on a fraudulent basis, from obtaining business from any organ of state for a period not exceeding 10 years, after the audi alteram partem (hear the other side) rule has

been applied; and

- (e) forward the matter for criminal prosecution

Witnesses

1.....

2.

.....
Signature(s) of bidders

Date:

Address:

.....

.....

PART L

MBD 6.2

DECLARATION CERTIFICATE FOR LOCAL PRODUCTION AND CONTENT

This Municipal Bidding Document (MBD) must form part of all bids invited. It contains general information and serves as a declaration form for local content (local production and local content are used interchangeably).

Before completing this declaration, bidders must study the General Conditions, Definitions, Directives applicable in respect of Local Content as prescribed in the Preferential Procurement Regulations, 2011 and the South African Bureau of Standards (SABS) approved technical specification number SATS 1286:201x.

1. General Conditions

- 1.1. Preferential Procurement Regulations, 2011 (Regulation 9 (1) and 9.(3) make provision for the promotion of local production and content.
- 1.2. Regulation 9 (1) prescribes that in the case of designated sectors, where in the award of bids local production and content is of critical importance, such bids must be advertised with the specific bidding condition that only locally produced goods, services or works or locally manufactured goods, with a stipulated minimum threshold for local production and content will be considered.
- 1.3. Regulation 9 (3) prescribes that where there is no designated sector, a specific bidding condition may be included, that only locally produced services, works or goods or locally manufactured goods with a stipulated minimum threshold for local production and content, will be considered.
- 1.4. Where necessary, for bids referred to in paragraphs 1.2 and 1.3 above, a two stage bidding process may be followed, where the first stage involves a minimum threshold for local production and content and the second stage price and B-BBEE.
- 1.5. A person awarded a contract in relation to a designated sector, may not sub-contract in such a manner that the local production and content of the overall value of the contract is reduced to below the stipulated minimum threshold.
- 1.6. The local content (LC) as a percentage of the bid price must be calculated in accordance with the SABS approved technical specification number SATS 1286: 201x as follows:

$$LC = 1 - \frac{x}{y} \times 100$$

Where

x imported content

y bid price excluding value added tax (VAT)

Prices referred to in the determination of x must be converted to Rand (ZAR) by using the exchange rate published by the South African Reserve Bank (SARB) at 12:00 on the date, one week (7 calendar days) prior to the closing date of the bid as required in paragraph 4.1 below.

- 1.7. A bid will be disqualified if:

- The bidder fails to achieve the stipulated minimum threshold for local production and content indicated in paragraph 3 below; and.
- This declaration certificate is not submitted as part of the bid documentation.

2. Definitions

- 2.1. **“bid”** includes advertised competitive bids, written price quotations or proposals;
- 2.2. **“bid price”** price offered by the bidder, excluding value added tax (VAT);
- 2.3. **“contract”** means the agreement that results from the acceptance of a bid by an organ of state;
- 2.4. **“designated sector”** means a sector, sub-sector or industry that has been designated by the Department of Trade and Industry in line with national development and industrial policies for local production, where only locally produced services, works or goods or locally manufactured goods meet the stipulated minimum threshold for local production and content;
- 2.5. **“duly sign”** means a Declaration Certificate for Local Content that has been signed by the Chief Financial Officer or other legally responsible person nominated in writing by the Chief Executive, or senior member / person with management responsibility (close corporation, partnership or individual).
- 2.6. **“imported content”** means that portion of the bid price represented by the cost of
- 2.7. components, parts or materials which have been or are still to be imported (whether by the supplier or its subcontractors) and which costs are inclusive of the costs abroad, plus freight and other direct importation costs, such as landing costs, dock duties, import duty, sales duty or other similar tax or duty at the South African port of entry;
- 2.8. **“local content”** means that portion of the bid price which is not included in the imported content, provided that local manufacture does take place;
- 2.9. **“stipulated minimum threshold”** means that portion of local production and content as determined by the Department of Trade and Industry; and
- 2.10. **“Sub-contract”** means the primary contractor’s assigning, leasing, making out work to, or employing another person to support such primary contractor in the execution of part of a project in terms of the contract.

3. The stipulated minimum threshold(s) for local production and content for this bid is/are as follows:

<u>Description of services, works or goods</u>	<u>Stipulated minimum threshold</u>
_____	_____ %
_____	_____ %
_____	_____ %

4. Does any portion of the services, works or goods offered have any imported content?

YES / NO

4.1 If yes, the rate(s) of exchange to be used in this bid to calculate the local content as prescribed in paragraph 1.6 of the general conditions must be the rate(s) published by the SARB for the specific currency at 12:00 on the date, one week (7 calendar days) prior to the closing date of the bid.

The relevant rates of exchange information is accessible on www.reservebank.co.za. Indicate the rate(s) of exchange against the appropriate currency in the table below:

Currency	Rates of exchange
US Dollar	
Pound Sterling	
Euro	
Yen	
Other	

NB: Bidders must submit proof of the SARB rate (s) of exchange used.

Local content declaration by chief financial officer or other legally responsible person nominated in writing by the chief executive or senior member/person with management responsibility (close corporation, partnership or individual)

IN RESPECT OF BID No.

ISSUED BY: Greater Tzaneen Municipality

NB The obligation to complete, duly sign and submit this declaration cannot be transferred to an external authorized representative, auditor or any other third party acting on behalf of the bidder.

I, the undersigned, (full names),

Do hereby declare, in my capacity as

of(name of bidder entity), the

following:

(a) The facts contained herein are within my own personal knowledge.

(b) I have satisfied myself that the goods/services/works to be delivered in terms of the above-specified bid comply with the minimum local content requirements as specified in the bid, and as measured in terms of SATS 1286.

(c) The local content has been calculated using the formula given in clause 3 of SATS 1286, the rates of exchange indicated in paragraph 4.1 above and the following figures:

Bid price, excluding VAT (y)	R
Imported content (x)	R
Stipulated minimum threshold for Local content (paragraph 3 above)	
Local content % as calculated in terms of SATS 1286	

If the bid is for more than one product, a schedule of the local content by product shall be attached.

(d) I accept that the **Greater Tzaneen Municipality** has the right to request that the local content be verified in terms of the requirements of SATS 1286.

(e) I understand that the awarding of the bid is dependent on the accuracy of the information furnished in this application. I also understand that the submission of incorrect data, or data that are not verifiable as described in SATS 1286, may result in the Procurement Authority / Municipal / Municipal Entity imposing any or all of the remedies as provided for in Regulation 13 of the Preferential Procurement Regulations, 2011 promulgated under the Policy Framework Act (PPFA), 2000 (Act No. 5 of 2000).

Signature: _____

Date: _____

Witness No. 1 _____

Date: _____

Witness No. 2 _____

Date: _____

PART L

MBD 7.1

Contract form - rendering of services

This form must be filled in duplicate by both the service provider (part 1) and the purchaser (part 2). Both forms must be signed in the original so that the service provider and the purchaser would be in possession of originally signed contracts for their respective records.

Part 1 (to be filled in by the service provider)

1. I hereby undertake to render services described in the attached bidding documents to **Greater Tzaneen Municipality** in accordance with the requirements and task directives / proposals specifications stipulated in Bid Number.....at the price/s quoted. My offer/s remains binding upon me and open for acceptance by the Purchaser during the validity period indicated and calculated from the closing date of the bid.
2. The following documents shall be deemed to form and be read and construed as part of this agreement:
 - (i) Bidding documents,
 - Invitation to bid;
 - Tax clearance certificate;
 - Pricing schedule(s);
 - Filled in task directive/proposal;
 - Preference claims for Broad Based Black Economic Empowerment Status Level of Contribution in terms of the Preferential Procurement Regulations 2011;
 - Declaration of interest;
 - Declaration of Bidder's past SCM practices;
 - Certificate of Independent Bid Determination;
 - Special Conditions of Contract;
 - (ii) General Conditions of Contract; and
 - (iii) Other (specify)
3. I confirm that I have satisfied myself as to the correctness and validity of my bid; that the price(s) and rate(s) quoted cover all the services specified in the bidding documents; that the price(s) and rate(s) cover all my obligations and I accept that any mistakes regarding price(s) and rate(s) and calculations will be at my own risk.
4. I accept full responsibility for the proper execution and fulfilment of all obligations and conditions devolving on me under this agreement as the principal liable for the due fulfilment of this contract.
5. I declare that I have no participation in any collusive practices with any bidder or any other person regarding this or any other bid.

WITNESSES
1
2
DATE:

6. I confirm that I am duly authorised to sign this contract.

Name (print)
Capacity
Signature
Name of firm
Date

MBD 7.2

CONTRACT FORM - RENDERING OF SERVICES

PART 2 (TO BE FILLED IN BY THE PURCHASER)

1. I..... in my capacity as..... accept your bid under reference numberdated.....for the rendering of services indicated hereunder and/or further specified in the annexure(s).
2. An official order indicating service delivery instructions is forthcoming.
3. I undertake to make payment for the services rendered in accordance with the terms and conditions of the contract, within 30 (thirty) days after receipt of an invoice.

Description of Service	Price (all applicable taxes included)	Completion date	B-BBEE status level of contribution	Minimum threshold for local production and content (if applicable)

4. I confirm that I am duly authorized to sign this contract.

Signed at on

Name (print)

Signature

OFFICIAL STAMP

WITNESSES

1

2

DATE:

.....

PART M

MBD 8

DECLARATION OF BIDDER'S PAST SUPPLY CHAIN MANAGEMENT PRACTICES

- 1 This Municipal Bidding Document must form part of all bids invited.
- 2 It serves as a declaration to be used by municipalities and municipal entities in ensuring that when goods and services are being procured, all reasonable steps are taken to combat the abuse of the supply chain management system.
- 3 The bid of any bidder may be rejected if that bidder, or any of its directors have:
 - a. abused the municipality's / municipal entity's supply chain management system or committed any improper conduct in relation to such system;
 - b. been convicted for fraud or corruption during the past five years;
 - c. willfully neglected, reneged on or failed to comply with any government, municipal or other public sector contract during the past five years; or
 - d. Been listed in the Register for Tender Defaulters in terms of section 29 of the Prevention and Combating of Corrupt Activities Act (No 12 of 2004).
- 4 **In order to give effect to the above, the following questionnaire must be completed and submitted with the bid.**

Item	Question	Yes	No
4.1	<p>Is the bidder or any of its directors listed on the National Treasury's Database of Restricted Suppliers as companies or persons prohibited from doing business with the public sector?</p> <p>(Companies or persons who are listed on this Database were informed in writing of this restriction by the Accounting Officer/Authority of the institution that imposed the restriction after the <i>audi alteram partem</i> rule was applied).</p> <p>The Database of Restricted Suppliers now resides on the National Treasury's website (www.treasury.gov.za) and can be accessed by clicking on its link at the bottom of the home page.</p>	Yes <input type="checkbox"/>	No <input type="checkbox"/>
4.1.1	If so, furnish particulars:		
4.2	<p>Is the bidder or any of its directors listed on the Register for Tender Defaulters in terms of section 29 of the Prevention and Combating of Corrupt Activities Act (No 12 of 2004)?</p> <p>The Register for Tender Defaulters can be accessed on the National Treasury's website (www.treasury.gov.za) by clicking on its link at the bottom of the home page.</p>	Yes <input type="checkbox"/>	No <input type="checkbox"/>

Item	Question	Yes	No
4.2.1	If so, furnish particulars:		
4.3	Was the bidder or any of its directors convicted by a court of law (including a court of law outside the Republic of South Africa) for fraud or corruption during the past five years?	Yes <input type="checkbox"/>	No <input type="checkbox"/>
4.3.1	If so, furnish particulars:		
4.4	Does the bidder or any of its directors owe any municipal rates and taxes or municipal charges to the municipality / municipal entity, or to any other municipality / municipal entity, that is in arrears for more than three months?	Yes <input type="checkbox"/>	No <input type="checkbox"/>
4.4.1	If so, furnish particulars:		
4.5	Was any contract between the bidder and the municipality / municipal entity or any other organ of state terminated during the past five years on account of failure to perform on or comply with the contract?	Yes <input type="checkbox"/>	No <input type="checkbox"/>
4.7.1	If so, furnish particulars:		

CERTIFICATION

I, the undersigned (full name) certify that the information furnished on this declaration form true and correct. Accept that, in addition to cancellation of a contract, action may be taken against me should this declaration prove to be false.

.....
Signature

.....
Date

.....
Designation

.....
Name of Bidder

MBD 9

CERTIFICATE OF INDEPENDENT BID DETERMINATION

- 1 This Municipal Bidding Document (MBD) must form part of all bids¹ invited.
- 2 Section 4 (1) (b) (iii) of the Competition Act No. 89 of 1998, as amended, prohibits an agreement between, or concerted practice by, firms, or a decision by an association of firms, if it is between parties in a horizontal relationship and if it involves collusive bidding (or bid rigging).² Collusive bidding is a *pe se* prohibition meaning that it cannot be justified under any grounds.
- 3 Municipal Supply Regulation 38 (1) prescribes that a supply chain management policy must provide measures for the combating of abuse of the supply chain management system, and must enable the accounting officer, among others, to:
 - a. takes all reasonable steps to prevent such abuse;
 - b. rejects the bid of any bidder if that bidder or any of its directors has abused the supply chain management system of the municipality or municipal entity or has committed any improper conduct in relation to such system; and
 - c. cancel a contract awarded to a person if the person committed any corrupt or fraudulent act during the bidding process or the execution of the contract.
- 4 This MBD serves as a certificate of declaration that would be used by institutions to ensure that, when bids are considered, reasonable steps are taken to prevent any form of bid-rigging.
- 5 In order to give effect to the above, the attached Certificate of Bid Determination (MBD 9) must be completed and submitted with the bid:

¹ **Includes price quotations, advertised competitive bids, limited bids and proposals.**

² **Bid rigging (or collusive bidding) occurs when businesses, that would otherwise be expected to compete, secretly conspire to raise prices or lower the quality of goods and / or services for purchasers who wish to acquire goods and / or services through a bidding process. Bid rigging is, therefore, an agreement between competitors not to compete.**

CERTIFICATE OF INDEPENDENT BID DETERMINATION

I, the undersigned, in submitting the accompanying bid number:

Bid Description:

In response to the invitation for the bid made by **Greater Tzaneen Municipality**

Do hereby make the following statements that I certify to be true and complete in every respect:

I certify, on behalf of: _____ that:

(Name of Bidder)

1. I have read and I understand the contents of this Certificate;
2. I understand that the accompanying bid will be disqualified if this Certificate is found not to be true and complete in every respect;
3. I am authorized by the bidder to sign this Certificate, and to submit the accompanying bid, on behalf of the bidder;
4. Each person whose signature appears on the accompanying bid has been authorized by the bidder to determine the terms of, and to sign, the bid, on behalf of the bidder;
5. For the purposes of this Certificate and the accompanying bid, I understand that the word “competitor” shall include any individual or organization, other than the bidder, whether or not affiliated with the bidder, who:
 - (a) Has been requested to submit a bid in response to this bid invitation;
 - (b) Could potentially submit a bid in response to this bid invitation, based on their qualifications, abilities or experience; and
 - (c) Provides the same goods and services as the bidder and/or is in the same line of business as the bidder
6. The bidder has arrived at the accompanying bid independently from, and without consultation, communication, agreement or arrangement with any competitor. However, communication between partners in a joint venture or consortium³ will not be construed as collusive bidding.
7. In particular, without limiting the generality of paragraphs 6 above, there has been no consultation, communication, agreement or arrangement with any competitor regarding:
 - (a) Prices;
 - (b) Geographical area where product or service will be rendered (market allocation)
 - (c) Methods, factors or formulas used to calculate prices;
 - (d) The intention or decision to submit or not to submit, a bid;
 - (e) The submission of a bid which does not meet the specifications and conditions of the bid; or
 - (f) Bidding with the intention not to win the bid.
8. In addition, there have been no consultations, communications, agreements or arrangements with any competitor regarding the quality, quantity, specifications and conditions or delivery particulars of the products or services to which this bid invitation relates.
9. The terms of the accompanying bid have not been, and will not be, disclosed by the bidder, directly or indirectly, to any competitor, prior to the date and time of the official bid opening or of the awarding of the contract.

³ Joint venture or Consortium means an association of persons for the purpose of combining their expertise, property, capital, efforts, skill and knowledge in an activity for the execution of a contract.

10. I am aware that, in addition and without prejudice to any other remedy provided to combat any restrictive practices related to bids and contracts, bids that are suspicious will be reported to the Competition Commission for investigation and possible imposition of administrative penalties in terms of section 59 of the Competition Act No 89 of 1998 and or may be reported to the National Prosecuting Authority (NPA) for criminal investigation and or may be restricted from conducting business with the public sector for a period not exceeding ten (10) years in terms of the Prevention and Combating of Corrupt Activities Act No 12 of 2004 or any other applicable legislation.

.....

Signature

.....

Date

.....

Position

.....

Name of Bidder

Returnable Documents

Checklist On Minimum Requirements

To assist you with your tendering process, see a checklist on minimum requirements below:

No.	Minimum requirements	Tick	Comment if not attached
1.	Compulsory briefing session attended		
2.	Complete original bid document		
3.	CSD reports; B-BBEE Certificate/ Sworn affidavit		
4.	Valid Tax Clearance Certificate or Tax pin		
5.	CK/Company registration;		
6.	Certified ID copies of the shareholders;		
7.	Proof of Residence: Municipal statement account / letter from headman/Tribal Authority/Lease agreement		
8.	Company registration certificate showing percentage of shareholders / membership interest		
9.	Initial each page of the Conditions of Contact		
10.	All MBD Forms must be completed and signed		
11.	In case of a Joint Venture, Association or Consortium a formal contract agreement		
12.	Key personnel Experience		
13.	Company Experience		
14.	Plant and equipment		
15.	Responded as per the scope of work (compliance to specification/ conditions or term of references)		
16.	Detailed price schedule/ financial Bids		
17.	All/Any alterations initialled		

Company Representative (Name)

Signature